

8-bit Microcontroller

CMOS

F²MC-8FX MB95220H Series

MB95F222H/F223H
MB95F222K/F223K

■ DESCRIPTION

MB95220H are a series of general-purpose, single-chip microcontrollers. In addition to a compact instruction set, the microcontrollers of these series contain a variety of peripheral resources.

Note: F²MC is the abbreviation of FUJITSU Flexible Microcontroller.

■ FEATURES

- F²MC-8FX CPU core
 - Instruction set optimized for controllers
 - Multiplication and division instructions
 - 16-bit arithmetic operations
 - Bit test branch instructions
 - Bit manipulation instructions, etc.
- Clock
 - Selectable main clock source
 - External clock (up to 32.5 MHz, maximum machine clock frequency: 16.25 MHz)
 - Main internal CR clock (1/8/10 MHz ±3%, maximum machine clock frequency: 10 MHz)
 - Selectable subclock source
 - External clock (32.768 kHz)
 - Sub-internal CR clock (Typ: 100 kHz, Min: 50 kHz, Max: 200 kHz)
- Timer
 - 8/16-bit composite timer
 - Timebase timer
 - Watch prescaler
- LIN-UART (MB95F222H/F222K/F223H/F223K)
 - Full duplex double buffer
 - Capable of clock-synchronized serial data transfer and clock-asynchronous serial data transfer

(Continued)

For the information for microcontroller supports, see the following web site.

<http://edevic.fujitsu.com/micom/en-support/>

MB95220H Series

(Continued)

- External interrupt
 - Interrupt by edge detection (rising edge, falling edge, and both edges can be selected)
 - Can be used to wake up the device from different low power consumption (standby) modes
- 8/10-bit A/D converter
 - 8-bit or 10-bit resolution can be selected.
- Low power consumption (standby) modes
 - Stop mode
 - Sleep mode
 - Watch mode
 - Timebase timer mode
- I/O port (Max: 13) (MB95F222K/F223K)
 - General-purpose I/O ports (Max):
CMOS I/O: 11, N-ch open drain: 2
- I/O port (Max: 12) (MB95F222H/F223H)
 - General-purpose I/O ports (Max):
CMOS I/O: 11, N-ch open drain: 1
- On-chip debug
 - 1-wire serial control
 - Serial writing supported (asynchronous mode)
- Hardware/software watchdog timer
 - Built-in hardware watchdog timer
- Low-voltage detection reset circuit
 - Built-in low-voltage detector
- Clock supervisor counter
 - Built-in clock supervisor counter function
- Programmable port input voltage level
 - CMOS input level / hysteresis input level
- Flash memory security function
 - Protects the contents of flash memory

MB95220H Series

■ PRODUCT LINE-UP

Part number	MB95F223H	MB95F222H	MB95F223K	MB95F222K
Parameter				
Type	Flash memory product			
Clock supervisor counter	It supervises the main clock oscillation.			
ROM capacity	8 KB	4 KB	8 KB	4 KB
RAM capacity	496 B	240 B	496 B	240 B
Low-voltage detection reset	No		Yes	
Reset input	Dedicated		Selected by software	
CPU functions	Number of basic instructions : 136 Instruction bit length : 8 bits Instruction length : 1 to 3 bytes Data bit length : 1, 8, and 16 bits Minimum instruction execution time : 61.5 ns (with machine clock = 16.25 MHz) Interrupt processing time : 0.6 μs (with machine clock = 16.25 MHz)			
General-purpose I/O	I/O ports (Max): 12 CMOS: 11, N-ch: 1		I/O ports (Max): 13 CMOS: 11, N-ch: 2	
Timebase timer	Interrupt cycle : 0.256 ms - 8.3 s (when external clock = 4 MHz)			
Hardware/software watchdog timer	Reset generation cycle Main oscillation clock at 10 MHz : 105 ms (Min) The sub-CR clock can be used as the source clock of the hardware watchdog timer.			
Wild register	It can be used to replace three bytes of data.			
LIN-UART	A wide range of communication speed can be selected by a dedicated reload timer. It has a full duplex double buffer. Clock-synchronized serial data transfer and clock-asynchronized serial data transfer is enabled. The LIN function can be used as a LIN master or a LIN slave.			
8/10-bit A/D converter	5 ch. 8-bit or 10-bit resolution can be selected.			
8/16-bit composite timer	1 ch. The timer can be configured as an "8-bit timer x 2 channels" or a "16-bit timer x 1 channel". It has built-in timer function, PWC function, PWM function and input capture function. Count clock: it can be selected from internal clocks (seven types) and external clocks. It can output square wave.			
External interrupt	6 ch. Interrupt by edge detection (The rising edge, falling edge, or both edges can be selected.) It can be used to wake up the device from standby modes.			
On-chip debug	1-wire serial control It supports serial writing. (asynchronous mode)			

(Continued)

MB95220H Series

(Continued)

Part number	MB95F223H	MB95F222H	MB95F223K	MB95F222K
Parameter				
Watch prescaler	Eight different time intervals can be selected.			
Flash memory	<p>It supports automatic programming, Embedded Algorithm, write/erase/erase-suspend/erase-resume commands. It has a flag indicating the completion of the operation of Embedded Algorithm.</p> <p>Number of write/erase cycles: 100000 Data retention time: 20 years For write/erase, external Vpp(+10 V) input is required. Flash security feature for protecting the contents of the flash</p>			
Standby mode	Sleep mode, stop mode, watch mode, timebase timer mode			
Package	DIP-16P-M06 FPT-16P-M06			

■ PACKAGES AND CORRESPONDING PRODUCTS

Part number				
Package	MB95F223H	MB95F222H	MB95F223K	MB95F222K
DIP-16P-M06	○	○	○	○
FPT-16P-M06	○	○	○	○

○: Available

■ DIFFERENCES AMONG PRODUCTS AND NOTES ON PRODUCT SELECTION

- Current consumption

When using the on-chip debug function, take account of the current consumption of flash erase/program.

For details of current consumption, see “■ ELECTRICAL CHARACTERISTICS”.

- Package

For details of information on each package, see “■ PACKAGES AND CORRESPONDING PRODUCTS” and “■ PACKAGE DIMENSIONS”.

- Operating voltage

The operating voltage varies, depending on whether the on-chip debug function is used or not.

For details of the operating voltage, see “■ ELECTRICAL CHARACTERISTICS”.

- On-chip debug function

The on-chip debug function requires that V_{CC} , V_{SS} and 1 serial-wire be connected to an evaluation tool. In addition, if the flash memory data has to be updated, the $\overline{RST}/PF2$ pin must also be connected to the same evaluation tool.

■ PIN ASSIGNMENT

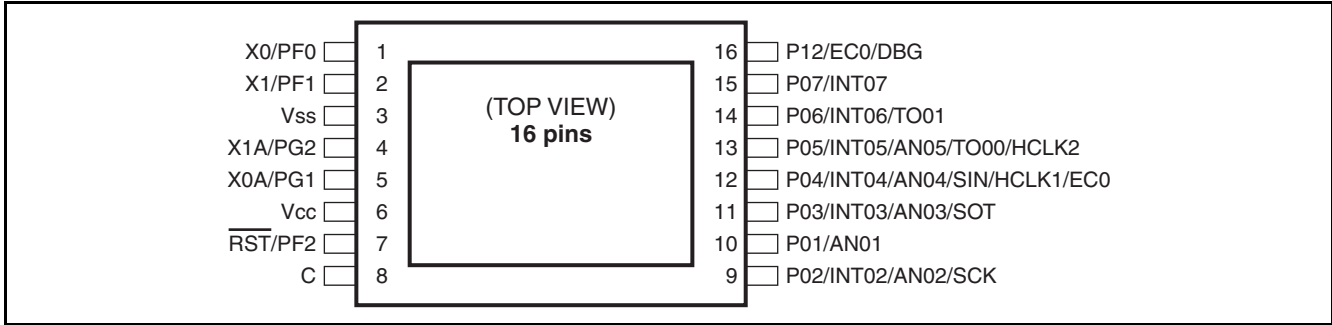

MB95220H Series

■ PIN DESCRIPTION (MB95220H Series)

Pin no.	Pin name	I/O circuit type*	Function
1	PF0	B	General-purpose I/O port
	X0		Main clock input oscillation pin
2	PF1	B	General-purpose I/O port
	X1		Main clock I/O oscillation pin
3	V _{SS}	—	Power supply pin (GND)
4	PG2	C	General-purpose I/O port
	X1A		Subclock I/O oscillation pin
5	PG1	C	General-purpose I/O port
	X0A		Subclock input oscillation pin
6	V _{CC}	—	Power supply pin
7	PF2	A	General-purpose I/O port
	$\overline{\text{RST}}$		Reset pin This pin is a dedicated reset pin in MB95F222H/F223H.
8	C	—	Capacitor connection pin
9	P02	E	General-purpose I/O port
	INT02		External interrupt input pin
	AN02		A/D converter analog input pin
	SCK		LIN-UART clock I/O pin
10	P01	E	General-purpose I/O port
	AN01		A/D converter analog input pin
11	P03	E	General-purpose I/O port
	INT03		External interrupt input pin
	AN03		A/D converter analog input pin
	SOT		LIN-UART data output pin
12	P04	F	General-purpose I/O port
	INT04		External interrupt input pin
	AN04		A/D converter analog input pin
	SIN		LIN-UART data input pin
	HCLK1		External clock input pin
	ECO		8/16-bit composite timer ch. 0 clock input pin

(Continued)

(Continued)

Pin no.	Pin name	I/O circuit type*	Function
13	P05	E	General-purpose I/O port High-current port
	INT05		External interrupt input pin
	AN05		A/D converter analog input pin
	TO00		8/16-bit composite timer ch. 0 clock input pin
	HCLK2		External clock input pin
14	P06	G	General-purpose I/O port High-current port
	INT06		External interrupt input pin
	TO01		8/16-bit composite timer ch. 0 clock input pin
15	P07	G	General-purpose I/O port
	INT07		External interrupt input pin
16	P12	H	General-purpose I/O port
	EC0		8/16-bit composite timer ch. 0 clock input pin
	DBG		DBG input pin

*: For the I/O circuit types, see "■ I/O CIRCUIT TYPE".

MB95220H Series

I/O CIRCUIT TYPE

Type	Circuit	Remarks
A		<ul style="list-style-type: none"> • N-ch open drain output • Hysteresis input • Reset output
B		<ul style="list-style-type: none"> • Oscillation circuit • High-speed side Feedback resistance: approx. 1 MΩ • CMOS output • Hysteresis input
C		<ul style="list-style-type: none"> • Oscillation circuit • Low-speed side Feedback resistance: approx. 10 MΩ • CMOS output • Hysteresis input • Pull-up control available

(Continued)

(Continued)

Type	Circuit	Remarks
D	<p> Digital output Digital output Standby control Hysteresis input </p>	<ul style="list-style-type: none"> • CMOS output • Hysteresis input
E	<p> Pull-up control Digital output Digital output Analog input A/D control Standby control Hysteresis input </p>	<ul style="list-style-type: none"> • CMOS output • Hysteresis input • Pull-up control available
F	<p> Pull-up control Digital output Digital output Analog input A/D control Standby control Hysteresis input CMOS input </p>	<ul style="list-style-type: none"> • CMOS output • Hysteresis input • CMOS input • Pull-up control available
G	<p> Pull-up control Digital output Digital output Standby control Hysteresis input </p>	<ul style="list-style-type: none"> • Hysteresis input • CMOS output • Pull-up control available
H	<p> Standby control Hysteresis input Digital output N-ch </p>	<ul style="list-style-type: none"> • N-ch open drain output • Hysteresis input

■ NOTES ON DEVICE HANDLING

- Preventing latch-ups

When using the device, ensure that the voltage applied does not exceed the maximum voltage rating.

In a CMOS IC, if a voltage higher than V_{CC} or a voltage lower than V_{SS} is applied to an input/output pin that is neither a medium-withstand voltage pin nor a high-withstand voltage pin, or if a voltage out of the rating range of power supply voltage mentioned in 1. Absolute Maximum Ratings of ■ ELECTRICAL CHARACTERISTICS” is applied to the V_{CC} pin or the V_{SS} pin, a latch-up may occur.

When a latch-up occurs, power supply current increases significantly, which may cause a component to be thermally destroyed.

- Stabilizing supply voltage

Supply voltage must be stabilized.

A malfunction may occur when power supply voltage fluctuates rapidly even though the fluctuation is within the guaranteed operating range of the V_{CC} power supply voltage.

As a rule of voltage stabilization, suppress voltage fluctuation so that the fluctuation in V_{CC} ripple (p-p value) at the commercial frequency (50 Hz/60 Hz) does not exceed 10% of the standard V_{CC} value, and the transient fluctuation rate does not exceed 0.1 V/ms at a momentary fluctuation such as switching the power supply.

- Notes on using the external clock

When an external clock is used, oscillation stabilization wait time is required for power-on reset, wake-up from subclock mode or stop mode.

■ PIN CONNECTION

- Treatment of unused pins

If an unused input pin is left unconnected, a component may be permanently damaged due to malfunctions or latch-ups. Always pull up or pull down an unused input pin through a resistor of at least 2 k Ω . Set an unused input/output pin to the output state and leave it unconnected, or set it to the input state and treat it the same as an unused input pin. If there is an unused output pin, leave it unconnected.

- Power supply pins

To reduce unnecessary electro-magnetic emission, prevent malfunctions of strobe signals due to an increase in the ground level, and conform to the total output current standard, always connect the V_{CC} pin and the V_{SS} pin to the power supply and ground outside the device. In addition, connect the current supply source to the V_{CC} pin and the V_{SS} pin with low impedance.

It is also advisable to connect a ceramic capacitor of approximately 0.1 μ F as a bypass capacitor between the V_{CC} pin and the V_{SS} pin at a location close to this device.

- DBG pin

Connect the DBG pin directly to an external pull-up resistor.

To prevent the device from unintentionally entering the debug mode due to noise, minimize the distance between the DBG pin and the V_{CC} or V_{SS} pin when designing the layout of the printed circuit board.

The DBG pin should not stay at “L” level after power-on until the reset output is released.

- \overline{RST} pin

Connect the \overline{RST} pin directly to an external pull-up resistor.

To prevent the device from unintentionally entering the reset mode due to noise, minimize the distance between the \overline{RST} pin and the V_{CC} or V_{SS} pin when designing the layout of the printed circuit board.

The \overline{RST} /PF2 pin functions as the reset input/output pin after power-on. In addition, the reset output of the \overline{RST} /PF2 pin can be enabled by the RSTOE bit of the SYSC register, and the reset input function and the general purpose I/O function can be selected by the RSTEN bit of the SYSC register.

- C pin

Use a ceramic capacitor or a capacitor with equivalent frequency characteristics. The bypass capacitor for the V_{CC} pin must have a capacitance larger than C_s . For the connection to a smoothing capacitor C_s , see the diagram below. To prevent the device from unintentionally entering a mode to which the device is not set to transit due to noise, minimize the distance between the C pin and C_s and the distance between C_s and the V_{SS} pin when designing the layout of a printed circuit board.

- DBG/ \overline{RST} /C pin connection diagram

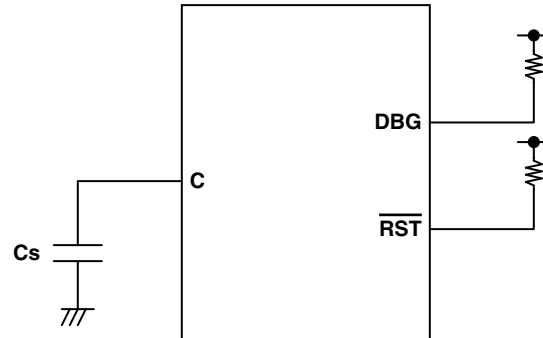

MB95220H Series

■ BLOCK DIAGRAM (MB95220H Series)

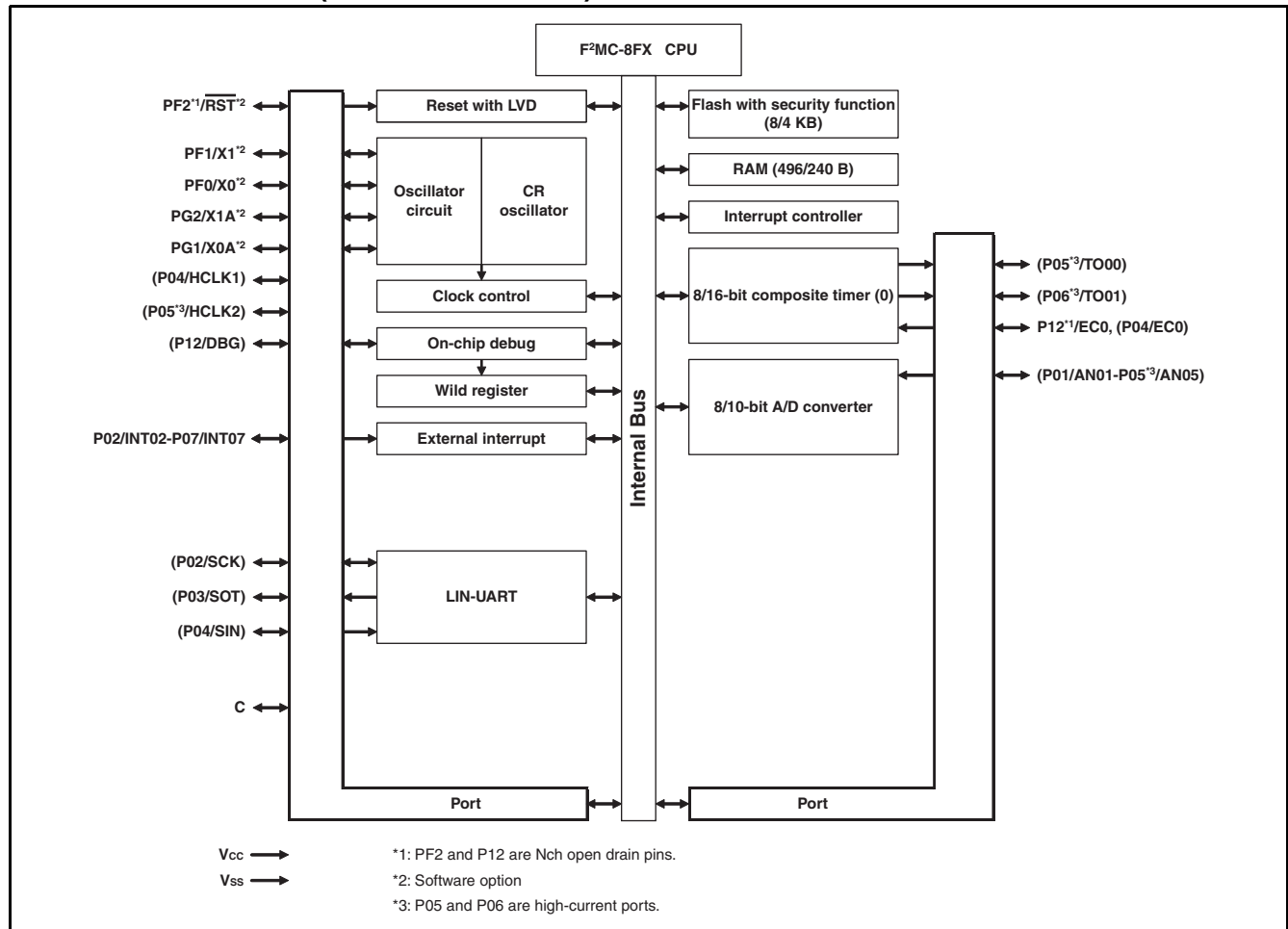

■ CPU CORE

• Memory Space

The memory space of the MB95220H Series is 64 KB in size, and consists of an I/O area, a data area, and a program area. The memory space includes areas intended for specific purposes such as general-purpose registers and a vector table. The memory maps of the MB95220H Series are shown below.

• Memory Maps

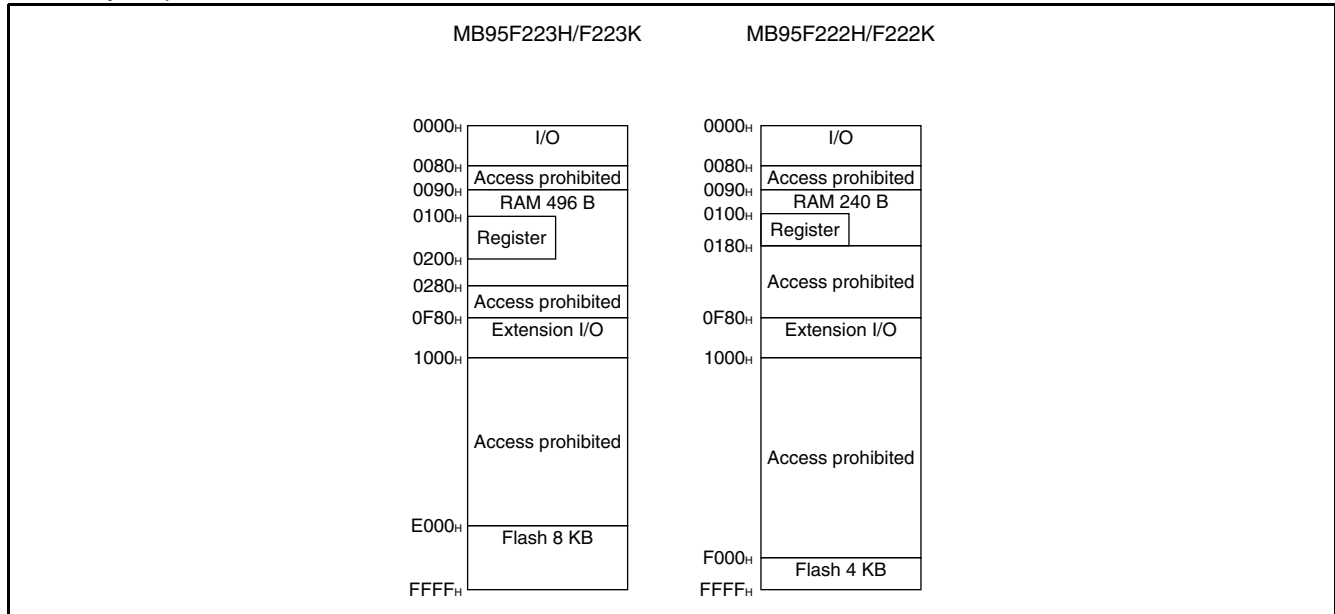

MB95220H Series

■ I/O MAP (MB95220H Series)

Address	Register abbreviation	Register name	R/W	Initial value
0000 _H	PDR0	Port 0 data register	R/W	00000000 _B
0001 _H	DDR0	Port 0 direction register	R/W	00000000 _B
0002 _H	PDR1	Port 1 data register	R/W	00000000 _B
0003 _H	DDR1	Port 1 direction register	R/W	00000000 _B
0004 _H	—	(Disabled)	—	—
0005 _H	WATR	Oscillation stabilization wait time setting register	R/W	11111111 _B
0006 _H	—	(Disabled)	—	—
0007 _H	SYCC	System clock control register	R/W	0000X011 _B
0008 _H	STBC	Standby control register	R/W	00000XXX _B
0009 _H	RSRR	Reset source register	R	XXXXXXXX _B
000A _H	TBTC	Timebase timer control register	R/W	00000000 _B
000B _H	WPCR	Watch prescaler control register	R/W	00000000 _B
000C _H	WDTC	Watchdog timer control register	R/W	00000000 _B
000D _H	SYCC2	System clock control register 2	R/W	XX100011 _B
000E _H to 0015 _H	—	(Disabled)	—	—
0016 _H	—	(Disabled)	—	—
0017 _H	—	(Disabled)	—	—
0018 _H to 0027 _H	—	(Disabled)	—	—
0028 _H	PDRF	Port F data register	R/W	00000000 _B
0029 _H	DDRF	Port F direction register	R/W	00000000 _B
002A _H	PDRG	Port G data register	R/W	00000000 _B
002B _H	DDRG	Port G direction register	R/W	00000000 _B
002C _H	PUL0	Port 0 pull-up register	R/W	00000000 _B
002D _H to 0034 _H	—	(Disabled)	—	—
0035 _H	PULG	Port G pull-up register	R/W	00000000 _B
0036 _H	T01CR1	8/16-bit composite timer 01 status control register 1 ch. 0	R/W	00000000 _B
0037 _H	T00CR1	8/16-bit composite timer 00 status control register 1 ch. 0	R/W	00000000 _B
0038 _H	—	(Disabled)	—	—
0039 _H	—	(Disabled)	—	—
003A _H to 0048 _H	—	(Disabled)	—	—
0049 _H	EIC10	External interrupt circuit control register ch. 2/ch. 3	R/W	00000000 _B

(Continued)

MB95220H Series

Address	Register abbreviation	Register name	R/W	Initial value
004A _H	EIC20	External interrupt circuit control register ch. 4/ch. 5	R/W	00000000 _B
004B _H	EIC30	External interrupt circuit control register ch. 6/ch. 7	R/W	00000000 _B
004C _H to 004F _H	—	(Disabled)	—	—
0050 _H	SCR	LIN-UART serial control register	R/W	00000000 _B
0051 _H	SMR	LIN-UART serial mode register	R/W	00000000 _B
0052 _H	SSR	LIN-UART serial status register	R/W	00001000 _B
0053 _H	RDR/TDR	LIN-UART receive/transmit data register	R/W	00000000 _B
0054 _H	ESCR	LIN-UART extended status control register	R/W	00000100 _B
0055 _H	ECCR	LIN-UART extended communication control register	R/W	000000XX _B
0056 _H to 006B _H	—	(Disabled)	—	—
006C _H	ADC1	8/10-bit A/D converter control register 1	R/W	00000000 _B
006D _H	ADC2	8/10-bit A/D converter control register 2	R/W	00000000 _B
006E _H	ADDH	8/10-bit A/D converter data register (Upper)	R/W	00000000 _B
006F _H	ADDL	8/10-bit A/D converter data register (Lower)	R/W	00000000 _B
0070 _H , 0071 _H	—	(Disabled)	—	—
0072 _H	FSR	Flash memory status register	R/W	000X0000 _B
0073 _H to 0075 _H	—	(Disabled)	—	—
0076 _H	WREN	Wild register address compare enable register	R/W	00000000 _B
0077 _H	WROR	Wild register data test setting register	R/W	00000000 _B
0078 _H	—	Mirror of register bank pointer (RP) and direct bank pointer (DP)	—	—
0079 _H	ILR0	Interrupt level setting register 0	R/W	11111111 _B
007A _H	ILR1	Interrupt level setting register 1	R/W	11111111 _B
007B _H	ILR2	Interrupt level setting register 2	R/W	11111111 _B
007C _H	—	(Disabled)	—	—
007D _H	ILR4	Interrupt level setting register 4	R/W	11111111 _B
007E _H	ILR5	Interrupt level setting register 5	R/W	11111111 _B
007F _H	—	(Disabled)	—	—
0F80 _H	WRARH0	Wild register address setting register (Upper) ch. 0	R/W	00000000 _B

(Continued)

MB95220H Series

Address	Register abbreviation	Register name	R/W	Initial value
0F81 _H	WRARL0	Wild register address setting register (Lower) ch. 0	R/W	00000000 _B
0F82 _H	WRDR0	Wild register data setting register ch. 0	R/W	00000000 _B
0F83 _H	WRARH1	Wild register address setting register (Upper) ch. 1	R/W	00000000 _B
0F84 _H	WRARL1	Wild register address setting register (Lower) ch. 1	R/W	00000000 _B
0F85 _H	WRDR1	Wild register data setting register ch. 1	R/W	00000000 _B
0F86 _H	WRARH2	Wild register address setting register (Upper) ch. 2	R/W	00000000 _B
0F87 _H	WRARL2	Wild register address setting register (Lower) ch. 2	R/W	00000000 _B
0F88 _H	WRDR2	Wild register data setting register ch. 2	R/W	00000000 _B
0F89 _H to 0F91 _H	—	(Disabled)	—	—
0F92 _H	T01CR0	8/16-bit composite timer 01 status control register 0 ch. 0	R/W	00000000 _B
0F93 _H	T00CR0	8/16-bit composite timer 00 status control register 0 ch. 0	R/W	00000000 _B
0F94 _H	T01DR	8/16-bit composite timer 01 data register ch. 0	R/W	00000000 _B
0F95 _H	T00DR	8/16-bit composite timer 00 data register ch. 0	R/W	00000000 _B
0F96 _H	TMCR0	8/16-bit composite timer 00/01 timer mode control register ch. 0	R/W	00000000 _B
0F97 _H	—	(Disabled)	—	—
0F98 _H	—	(Disabled)	—	—
0F99 _H	—	(Disabled)	—	—
0F9A _H	—	(Disabled)	—	—
0F9B _H	—	(Disabled)	—	—
0F9C _H to 0FBB _H	—	(Disabled)	—	—
0FBC _H	BGR1	LIN-UART baud rate generator register 1	R/W	00000000 _B
0FBD _H	BGR0	LIN-UART baud rate generator register 0	R/W	00000000 _B
0FBE _H to 0FC2 _H	—	(Disabled)	—	—
0FC3 _H	AIDRL	A/D input disable register (Lower)	R/W	00000000 _B
0FC4 _H to 0FE3 _H	—	(Disabled)	—	—
0FE4 _H	CRT _H	Main CR clock trimming register (Upper)	R/W	1XXXXXXX _B
0FE5 _H	CRT _L	Main CR clock trimming register (Lower)	R/W	000XXXXX _B

(Continued)

(Continued)

Address	Register abbreviation	Register name	R/W	Initial value
0FE6 _H , 0FE7 _H	—	(Disabled)	—	—
0FE8 _H	SYSC	System configuration register	R/W	11000011 _B
0FE9 _H	CMCR	Clock monitoring control register	R/W	00000000 _B
0FEA _H	CMDR	Clock monitoring data register	R/W	00000000 _B
0FEB _H	WDTH	Watchdog timer selection ID register (Upper)	R/W	XXXXXXXX _B
0FEC _H	WDTL	Watchdog timer selection ID register (Lower)	R/W	XXXXXXXX _B
0FED _H	—	(Disabled)	—	—
0FEE _H	ILSR	Input level select register	R/W	00000000 _B
0FEF _H to 0FFF _H	—	(Disabled)	—	—

- R/W access symbols

R/W : Readable / Writable
 R : Read only
 W : Write only

- Initial value symbols

0 : The initial value of this bit is "0".
 1 : The initial value of this bit is "1".
 X : The initial value of this bit is undefined.

Note: Do not write to an address that is "(Disabled)". If a "(Disabled)" address is read, an undefined value is returned.

MB95220H Series

■ INTERRUPT SOURCE TABLE (MB95220H Series)

Interrupt source	Interrupt request number	Vector table address		Bit name of interrupt level setting register	Priority order of interrupt sources of the same level (occurring simultaneously)
		Upper	Lower		
External interrupt ch. 4	IRQ0	FFFA _H	FFFB _H	L00 [1:0]	<div style="text-align: center;"> High ↑ ↓ Low </div>
External interrupt ch. 5	IRQ1	FFF8 _H	FFF9 _H	L01 [1:0]	
External interrupt ch. 2	IRQ2	FFF6 _H	FFF7 _H	L02 [1:0]	
External interrupt ch. 6					
External interrupt ch. 3	IRQ3	FFF4 _H	FFF5 _H	L03 [1:0]	
External interrupt ch. 7					
—	IRQ4	FFF2 _H	FFF3 _H	L04 [1:0]	
8/16-bit composite timer ch. 0 (Lower)	IRQ5	FFF0 _H	FFF1 _H	L05 [1:0]	
8/16-bit composite timer ch. 0 (Upper)	IRQ6	FFEE _H	FFEF _H	L06 [1:0]	
LIN-UART (reception)	IRQ7	FFEC _H	FFED _H	L07 [1:0]	
LIN-UART (transmission)	IRQ8	FFEA _H	FFEB _H	L08 [1:0]	
—	IRQ9	FFE8 _H	FFE9 _H	L09 [1:0]	
—	IRQ10	FFE6 _H	FFE7 _H	L10 [1:0]	
—	IRQ11	FFE4 _H	FFE5 _H	L11 [1:0]	
—	IRQ12	FFE2 _H	FFE3 _H	L12 [1:0]	
—	IRQ13	FFE0 _H	FFE1 _H	L13 [1:0]	
—	IRQ14	FFDE _H	FFDF _H	L14 [1:0]	
—	IRQ15	FFDC _H	FFDD _H	L15 [1:0]	
—	IRQ16	FFDA _H	FFDB _H	L16 [1:0]	
—	IRQ17	FFD8 _H	FFD9 _H	L17 [1:0]	
8/10-bit A/D converter	IRQ18	FFD6 _H	FFD7 _H	L18 [1:0]	
Timebase timer	IRQ19	FFD4 _H	FFD5 _H	L19 [1:0]	
Watch prescaler	IRQ20	FFD2 _H	FFD3 _H	L20 [1:0]	
—	IRQ21	FFD0 _H	FFD1 _H	L21 [1:0]	
—	IRQ22	FFCE _H	FFCF _H	L22 [1:0]	
Flash memory	IRQ23	FFCC _H	FFCD _H	L23 [1:0]	

■ ELECTRICAL CHARACTERISTICS

1. Absolute Maximum Ratings

Parameter	Symbol	Rating		Unit	Remarks
		Min	Max		
Power supply voltage*1	V _{CC}	V _{SS} -0.3	V _{SS} + 6	V	
Input voltage*1	V _{I1}	V _{SS} -0.3	V _{CC} + 0.3	V	Other than PF2*2
	V _{I2}	V _{SS} -0.3	10.5	V	PF2
Output voltage*1	V _O	V _{SS} -0.3	V _{SS} + 6	V	*2
Maximum clamp current	I _{CLAMP}	-2	+ 2	mA	Applicable to specific pins*3
Total maximum clamp current	Σ I _{CLAMP}	—	20	mA	Applicable to specific pins*3
“L” level maximum output current	I _{OL1}	—	15	mA	Other than P05, P06
	I _{OL2}		15		P05, P06
“L” level average current	I _{OLAV1}	—	4	mA	Other than P05, P06 Average output current = operating current × operating ratio (1 pin)
	I _{OLAV2}		12		P05, P06 Average output current = operating current × operating ratio (1 pin)
“L” level total maximum output current	ΣI _{OL}	—	100	mA	
“L” level total average output current	ΣI _{OLAV}	—	50	mA	Total average output current = operating current × operating ratio (Total number of pins)
“H” level maximum output current	I _{OH1}	—	-15	mA	Other than P05, P06
	I _{OH2}		-15		P05, P06
“H” level average current	I _{OHAV1}	—	-4	mA	Other than P05, P06 Average output current = operating current × operating ratio (1 pin)
	I _{OHAV2}		-8		P05, P06 Average output current = operating current × operating ratio (1 pin)
“H” level total maximum output current	ΣI _{OH}	—	-100	mA	
“H” level total average output current	ΣI _{OHAV}	—	-50	mA	Total average output current = operating current × operating ratio (Total number of pins)
Power consumption	P _d	—	320	mW	
Operating temperature	T _A	-40	+ 85	°C	
Storage temperature	T _{stg}	-55	+ 150	°C	

(Continued)

MB95220H Series

(Continued)

*1: The parameter is based on $V_{SS} = 0.0$ V.

*2: V_I and V_O must not exceed $V_{CC}+0.3$ V. V_I must not exceed the rated voltage. However, if the maximum current to/from an input is limited by means of an external component, the I_{CLAMP} rating is used instead of the V_I rating.

*3: Applicable to the following pins: P01 to P07, PG1, PG2, PF0, PF1

- Use under recommended operating conditions.
- Use with DC voltage (current).
- The HV (High Voltage) signal is an input signal exceeding the V_{CC} voltage. Always connect a limiting resistor between the HV (High Voltage) signal and the microcontroller before applying the HV (High Voltage) signal.
- The value of the limiting resistor should be set to a value at which the current to be input to the microcontroller pin when the HV (High Voltage) signal is input is below the standard value, irrespective of whether the current is transient current or stationary current.
- When the microcontroller drive current is low, such as in low power consumption modes, the HV (High Voltage) input potential may pass through the protective diode to increase the potential of the V_{CC} pin, affecting other devices.
- If the HV (High Voltage) signal is input when the microcontroller power supply is off (not fixed at 0 V), since power is supplied from the pins, incomplete operations may be executed.
- If the HV (High Voltage) input is input after power-on, since power is supplied from the pins, the voltage of power supply may not be sufficient to enable a power-on reset.
- Do not leave the HV (High Voltage) input pin unconnected.
- Example of a recommended circuit:

- Input/Output equivalent circuit

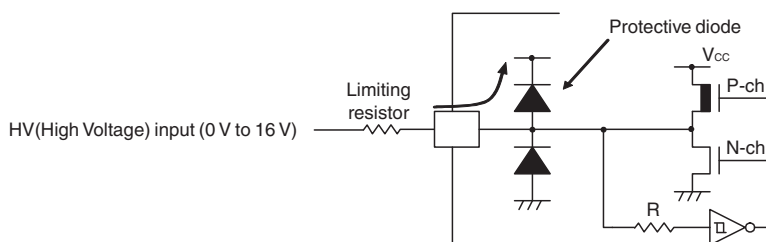

WARNING: Semiconductor devices can be permanently damaged by application of stress (voltage, current, temperature, etc.) in excess of absolute maximum ratings. Do not exceed these ratings.

2. Recommended Operating Conditions

(V_{SS} = 0.0 V)

Parameter	Symbol	Value		Unit	Remarks	
		Min	Max			
Power supply voltage	V _{CC}	2.4 ^{*1*2}	5.5 ^{*1}	V	In normal operation	Other than on-chip debug mode
		2.3	5.5		Hold condition in stop mode	
		2.9	5.5		In normal operation	On-chip debug mode
		2.3	5.5		Hold condition in stop mode	
Smoothing capacitor	C _S	0.022	1	μF	*3	
Operating temperature	T _A	-40	+85	°C	Other than on-chip debug mode	
		+5	+35		On-chip debug mode	

*1: The value varies depending on the operating frequency, the machine clock and the analog guaranteed range.

*2: The value is 2.88 V when the low-voltage detection reset is used.

*3: Use a ceramic capacitor or a capacitor with equivalent frequency characteristics. The bypass capacitor for the V_{CC} pin must have a capacitance larger than C_S. For the connection to a smoothing capacitor C_S, see the diagram below. To prevent the device from unintentionally entering an unknown mode due to noise, minimize the distance between the C pin and C_S and the distance between C_S and the V_{SS} pin when designing the layout of a printed circuit board.

- DBG / $\overline{\text{RST}}$ / C pin connection diagram

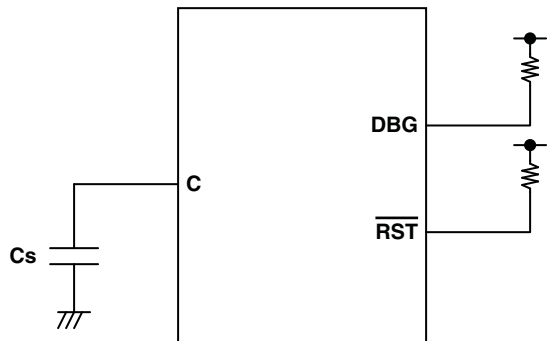

*: Since the DBG pin becomes a communication pin in on-chip debug mode, set a pull-up resistor value suiting the input/output specifications of P12/DBG.

WARNING: The recommended operating conditions are required in order to ensure the normal operation of the semiconductor device. All of the device's electrical characteristics are warranted when the device is operated within these ranges.

Always use semiconductor devices within their recommended operating condition ranges.

Operation outside these ranges may adversely affect reliability and could result in device failure.

No warranty is made with respect to uses, operating conditions, or combinations not represented on the data sheet. Users considering application outside the listed conditions are advised to contact their representatives beforehand.

MB95220H Series

3. DC Characteristics

($V_{CC} = 5.0\text{ V} \pm 10\%$, $V_{SS} = 0.0\text{ V}$, $T_A = -40^\circ\text{C}$ to $+85^\circ\text{C}$)

Parameter	Symbol	Pin name	Condition	Value			Unit	Remarks
				Min	Typ	Max		
"H" level input voltage	V_{IH1}	P04	*1	$0.7 V_{CC}$	—	$V_{CC}+0.3$	V	When CMOS input level (hysteresis input) is selected
	V_{IHS}	P01 to P07, P12, PF0, PF1, PG1, PG2	*1	$0.8 V_{CC}$	—	$V_{CC}+0.3$	V	Hysteresis input
	V_{IHM}	PF2	—	$0.7 V_{CC}$	—	10.5	V	Hysteresis input*3
"L" level input voltage	V_{IL}	P04	*1	$V_{SS}-0.3$	—	$0.3 V_{CC}$	V	When CMOS input level (hysteresis input) is selected
	V_{ILS}	P01 to P07, P12, PF0, PF1, PG1, PG2	*1	$V_{SS}-0.3$	—	$0.2 V_{CC}$	V	Hysteresis input
	V_{ILM}	PF2	—	$V_{SS}-0.3$	—	$0.3 V_{CC}$	V	Hysteresis input
Open-drain output application voltage	V_D	PF2, P12	—	$V_{SS}-0.3$	—	$V_{SS} + 5.5$	V	
"H" level output voltage	V_{OH1}	Output pins other than P05, P06, P12, PF2	$I_{OH} = -4\text{ mA}$	$V_{CC}-0.5$	—	—	V	
	V_{OH2}	P05, P06	$I_{OH} = -8\text{ mA}$	$V_{CC}-0.5$	—	—	V	
"L" level output voltage	V_{OL1}	Output pins other than P05, P06	$I_{OL} = 4\text{ mA}$	—	—	0.4	V	
	V_{OL2}	P05, P06	$I_{OL} = 12\text{ mA}$	—	—	0.4	V	
Input leak current (Hi-Z output leak current)	I_{LI}	All input pins	$0.0\text{ V} < V_I < V_{CC}$	-5	—	+5	μA	When pull-up resistance is disabled
Pull-up resistance	R_{PULL}	P01 to P07, PG1, PG2	$V_I = 0\text{ V}$	25	50	100	$\text{k}\Omega$	When pull-up resistance is enabled
Input capacitance	C_{IN}	Other than V_{CC} and V_{SS}	$f = 1\text{ MHz}$	—	5	15	pF	

(Continued)

MB95220H Series

($V_{CC} = 5.0\text{ V} \pm 10\%$, $V_{SS} = 0.0\text{ V}$, $T_A = -40^\circ\text{C}$ to $+85^\circ\text{C}$)

Parameter	Symbol	Pin name	Condition	Value			Unit	Remarks
				Min	Typ	Max		
Power supply current*2	I _{CC}	V _{CC} (External clock operation)	V _{CC} = 5.5 V F _{CH} = 32 MHz F _{MP} = 16 MHz Main clock mode (divided by 2)	—	13	17	mA	Flash memory product (except writing and erasing)
				—	33.5	39.5	mA	Flash memory product (at writing and erasing)
				—	15	21	mA	At A/D conversion
	I _{CCS}		V _{CC} = 5.5 V F _{CH} = 32 MHz F _{MP} = 16 MHz Main sleep mode (divided by 2)	—	5.5	9	mA	
	I _{CCCL}		V _{CC} = 5.5 V F _{CL} = 32 kHz F _{MPL} = 16 kHz Subclock mode (divided by 2) T _A = +25°C	—	65	153	μA	
	I _{CCLS}		V _{CC} = 5.5 V F _{CL} = 32 kHz F _{MPL} = 16 kHz Subsleep mode (divided by 2) T _A = +25°C	—	10	84	μA	
	I _{CCCT}		V _{CC} = 5.5 V F _{CL} = 32 kHz Watch mode Main stop mode T _A = +25°C	—	5	30	μA	
	I _{CCMCR}		V _{CC} = 5.5 V F _{CRH} = 10 MHz F _{MP} = 10 MHz Main CR clock mode	—	8.6	—	mA	
	I _{CCSCR}		V _{CC} = 5.5 V Sub-CR clock mode (divided by 2) T _A = +25°C	—	110	410	μA	

(Continued)

MB95220H Series

(Continued)

($V_{CC} = 5.0 V \pm 10\%$, $V_{SS} = 0.0 V$, $T_A = -40^\circ C$ to $+85^\circ C$)

Parameter	Symbol	Pin name	Condition	Value			Unit	Remarks
				Min	Typ	Max		
Power supply current*2	I_{CCTS}	V_{CC} (External clock operation)	$V_{CC} = 5.5 V$ $F_{CH} = 32 MHz$ Timebase timer mode $T_A = +25^\circ C$	—	1.1	3	mA	
	I_{CCH}		$V_{CC} = 5.5 V$ Substop mode $T_A = +25^\circ C$	—	3.5	22.5	μA	Main stop mode for single clock selection
	I_{LVD}	V_{CC}	Current consumption for low-voltage detection circuit only	—	37	54	μA	
	I_{CRH}		Current consumption for the internal main CR oscillator	—	0.5	0.6	mA	
	I_{CRL}		Current consumption for the internal sub-CR oscillator oscillating at 100 kHz	—	20	72	μA	

*1: The input level of P04 can be switched between “CMOS input level” and “hysteresis input level”. The input level selection register (ILSR) is used to switch between the two input levels.

*2: • The power supply current is determined by the external clock. When the low-voltage detection option is selected, the power-supply current will be the sum of adding the current consumption of the low-voltage detection circuit (I_{LVD}) to one of the value from I_{CC} to I_{CCH} . In addition, when both the low-voltage detection option and the CR oscillator are selected, the power supply current will be the sum of adding up the current consumption of the low-voltage detection circuit, the current consumption of the CR oscillators (I_{CRH} , I_{CRL}) and a specified value. In on-chip debug mode, the CR oscillator (I_{CRH}) and the low-voltage detection circuit are always enabled, and current consumption therefore increases accordingly.

- See "4. AC Characteristics: (1) Clock Timing" for F_{CH} and F_{CL} .
- See "4. AC Characteristics: (2) Source Clock/Machine Clock" for F_{MP} and F_{MPL} .

*3: PF2 act as high voltage supply for the flash memory during program and erase. It can tolerate high voltage input. For details, see section "6. Flash Memory Program/Erase Characteristics".

4. AC Characteristics

(1) Clock Timing

($V_{CC} = 2.4\text{ V to }5.5\text{ V}$, $V_{SS} = 0.0\text{ V}$, $T_A = -40^\circ\text{C to }+85^\circ\text{C}$)

Parameter	Symbol	Pin name	Condition	Value			Unit	Remarks	
				Min	Typ	Max			
Clock frequency	F_{CH}	X0, X1	—	1	—	16.25	MHz	When the main oscillation circuit is used	
		X0, HCLK1, HCLK2	X1 open	1	—	12	MHz	When the main external clock is used	
		X0, X1, HCLK1, HCLK2	—	1	—	32.5	MHz		
	F_{CRH}	—	—	—	9.7	10	10.3	MHz	When the main CR clock is used $2.4\text{ V} \leq V_{CC} < 5.5\text{ V}$ ($0^\circ\text{C} \leq T_A \leq 40^\circ\text{C}$)
					7.76	8	8.24	MHz	
					0.97	1	1.03	MHz	
					9.5	10	10.5	MHz	When the main CR clock is used $2.4\text{ V} \leq V_{CC} < 5.5\text{ V}$ ($-40^\circ\text{C} \leq T_A < 0^\circ\text{C}$, $40^\circ\text{C} < T_A \leq 85^\circ\text{C}$)
					7.6	8	8.4	MHz	
					0.95	1	1.05	MHz	
	F_{CL}	X0A, X1A	—	—	—	32.768	—	kHz	When the sub oscillation circuit is used
					—	32.768	—	kHz	When the sub-external clock is used
F_{CRL}	—	—	—	50	100	200	kHz	When the sub-CR clock is used	
Clock cycle time	t_{HCYL}	X0, X1	—	61.5	—	1000	ns	When the main oscillation circuit is used	
		X0, HCLK1, HCLK2	X1 open	83.4	—	1000	ns	When the external clock is used	
		X0, X1, HCLK1, HCLK2	—	30.8	—	1000	ns		
	t_{LCYL}	X0A, X1A	—	—	30.5	—	μs	When the subclock is used	

(Continued)

MB95220H Series

(Continued)

($V_{CC} = 2.4\text{ V to }5.5\text{ V}$, $V_{SS} = 0.0\text{ V}$, $T_A = -40^\circ\text{C to }+85^\circ\text{C}$)

Parameter	Symbol	Pin name	Condition	Value			Unit	Remarks
				Min	Typ	Max		
Input clock pulse width	t_{WH1} t_{WL1}	X0, HCLK1, HCLK2	X1 open	33.4	—	—	ns	When the external clock is used, the duty ratio should range between 40% and 60%.
		X0, X1, HCLK1, HCLK2	—	12.4	—	—	ns	
	t_{WH2} t_{WL2}	X0A	—	—	15.2	—	μs	
Input clock rise time and fall time	t_{CR} t_{CF}	X0, HCLK1, HCLK2	X1 open	—	—	5	ns	When the external clock is used
		X0, X1, HCLK1, HCLK2	—	—	—	5	ns	
CR oscillation start time	t_{CRHWK}	—	—	—	—	80	μs	When the main CR clock is used
	t_{CRLWK}	—	—	—	—	10	μs	When the sub-CR clock is used

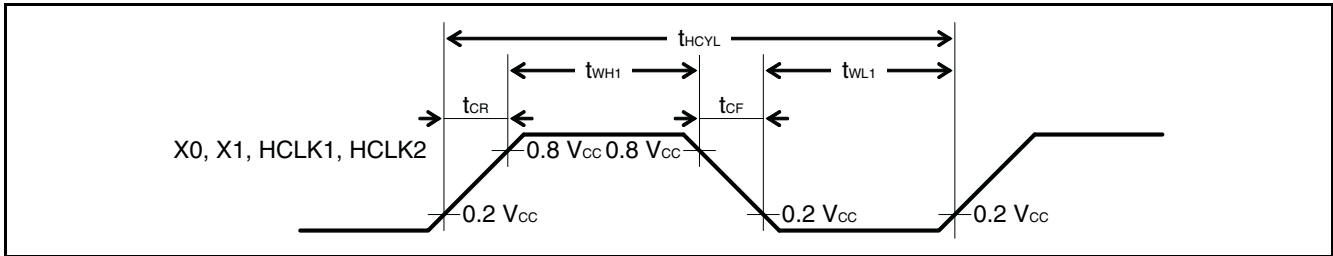

• Figure of main clock input port external connection

When a crystal oscillator or a ceramic oscillator is used

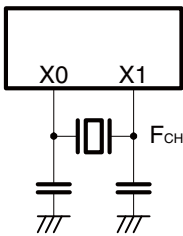

When the external clock is used (X1 is open)

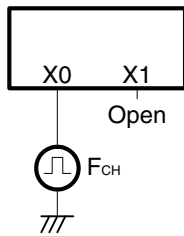

When the external clock is used

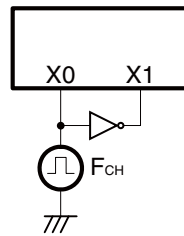

When the external clock is used

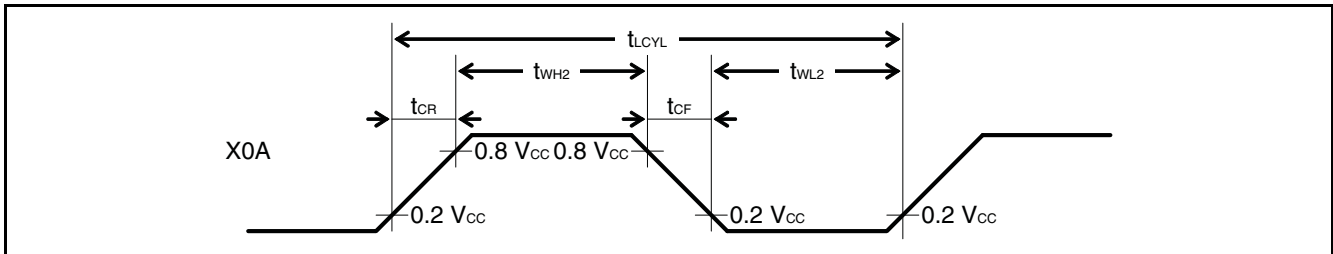
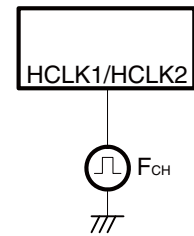

• Figure of subclock input port external connection

When a crystal oscillator or a ceramic oscillator is used

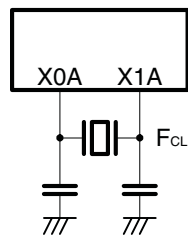

When the external clock is used

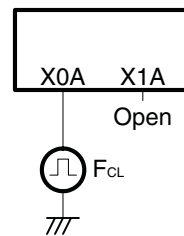

MB95220H Series

(2) Source Clock/Machine Clock

($V_{CC} = 5.0 V \pm 10\%$, $V_{SS} = 0.0 V$, $T_A = -40^\circ C$ to $+85^\circ C$)

Parameter	Symbol	Pin name	Value			Unit	Remarks
			Min	Typ	Max		
Source clock cycle time*1	t _{SCLK}	—	61.5	—	2000	ns	When the main external clock is used Min: F _{CH} = 32.5 MHz, divided by 2 Max: F _{CH} = 1 MHz, divided by 2
			100	—	1000	ns	When the main CR clock is used Min: F _{CRH} = 10 MHz Max: F _{CRH} = 1 MHz
			—	61	—	μs	When the sub-CR clock is used F _{CL} = 32.768 kHz, divided by 2
			—	20	—	μs	When the sub-oscillation clock is used F _{CRL} = 100 kHz, divided by 2
Source clock frequency	F _{SP}	—	0.5	—	16.25	MHz	When the main oscillation clock is used
			1	—	10	MHz	When the main CR clock is used
	—		16.384	—	kHz	When the sub-oscillation clock is used	
	—		50	—	kHz	When the sub-CR clock is used F _{CRL} = 100 kHz, divided by 2	
Machine clock cycle time*2 (minimum instruction execution time)	t _{MCLK}	—	61.5	—	32000	ns	When the main oscillation clock is used Min: F _{SP} = 16.25 MHz, no division Max: F _{SP} = 0.5 MHz, divided by 16
			100	—	16000	ns	When the main CR clock is used Min: F _{SP} = 10 MHz Max: F _{SP} = 1 MHz, divided by 16
			61	—	976.5	μs	When the sub-oscillation clock is used Min: F _{SPL} = 16.384 kHz, no division Max: F _{SPL} = 16.384 kHz, divided by 16
			20	—	320	μs	When the sub-CR clock is used Min: F _{SPL} = 50 kHz, no division Max: F _{SPL} = 50 kHz, divided by 16
Machine clock frequency	F _{MP}	—	0.031	—	16.25	MHz	When the main oscillation clock is used
			0.0625	—	10	MHz	When the main CR clock is used
	1.024		—	16.384	kHz	When the sub-oscillation clock is used	
	3.125		—	50	kHz	When the sub-CR clock is used F _{CRL} = 100 kHz	

*1: This is the clock before it is divided according to the division ratio set by the machine clock division ratio selection bits (SYCC : DIV1 and DIV0) . This source clock is divided to become a machine clock according to the division ratio set by the machine clock division ratio selection bits (SYCC : DIV1 and DIV0) . In addition, a source clock can be selected from the following.

- Main clock divided by 2
- Main CR clock
- Subclock divided by 2
- Sub-CR clock divided by 2

(Continued)

(Continued)

*2: This is the operating clock of the microcontroller. A machine clock can be selected from the following.

- Source clock (no division)
- Source clock divided by 4
- Source clock divided by 8
- Source clock divided by 16

MB95220H Series

- Schematic diagram of the clock generation block

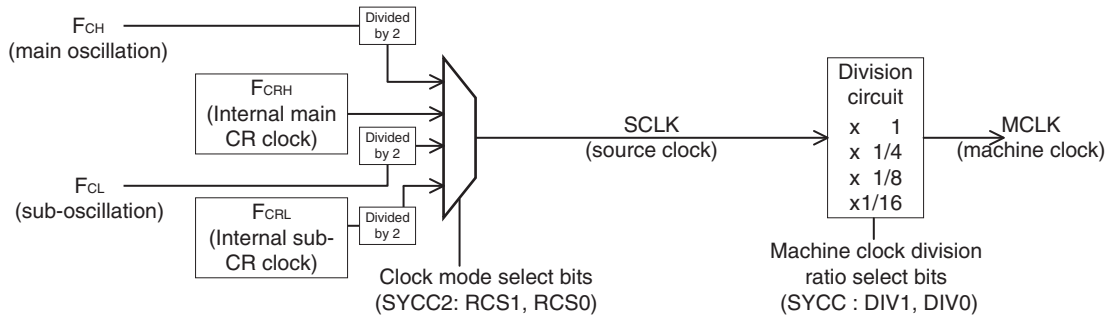

- Operating voltage - Operating frequency (When $T_A = -40^\circ\text{C}$ to $+85^\circ\text{C}$)
MB95220H (without the on-chip debug function)

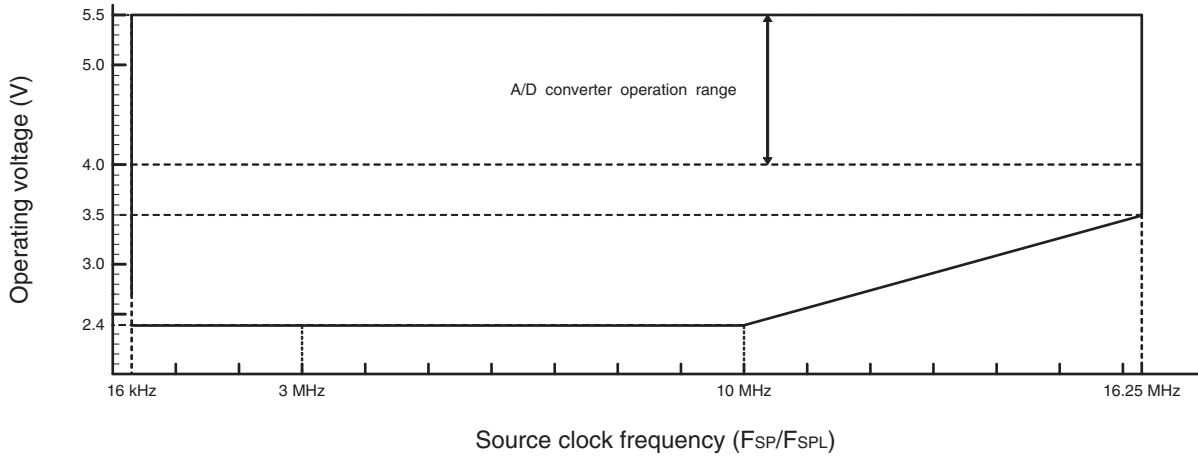

- Operating voltage - Operating frequency (When $T_A = -40^\circ\text{C}$ to $+85^\circ\text{C}$)
MB95220H (with the on-chip debug function)

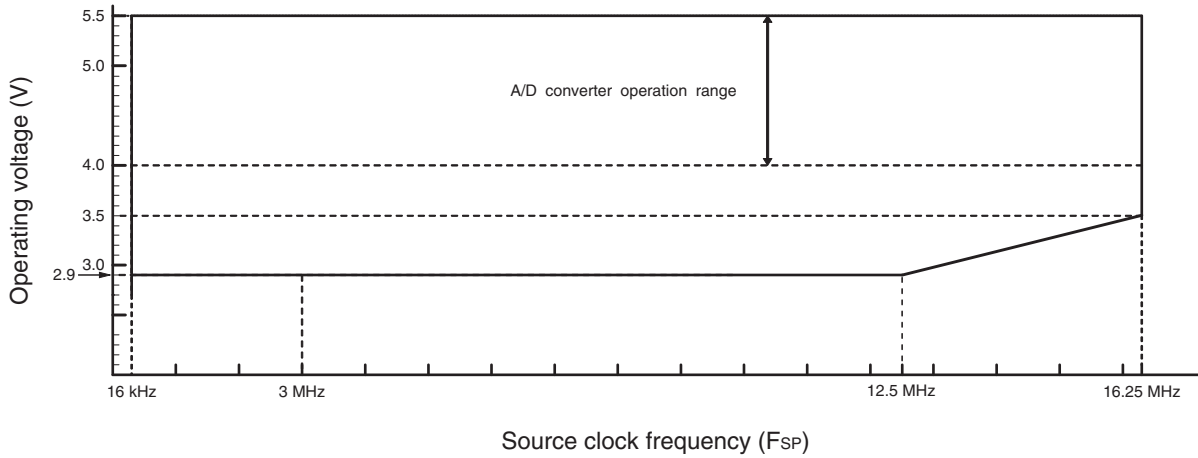

(3) External Reset

($V_{CC} = 5.0 V \pm 10\%$, $V_{SS} = 0.0 V$, $T_A = -40^\circ C$ to $+85^\circ C$)

Parameter	Symbol	Value		Unit	Remarks
		Min	Max		
\overline{RST} "L" level pulse width	t_{RSTL}	$2 t_{MCLK}^{*1}$	—	ns	In normal operation
		Oscillation time of the oscillator ^{*2} +100	—	μs	In stop mode, subclock mode, sub-sleep mode, watch mode, and power on
		100	—	μs	In timebase timer mode

*1: See "(2) Source Clock/Machine Clock" for t_{MCLK} .

*2: The oscillation time of an oscillator is the time for it to reach 90% of its amplitude. The crystal oscillator has an oscillation time of between several ms and tens of ms. The ceramic oscillator has an oscillation time of between hundreds of μs and several ms. The external clock has an oscillation time of 0 ms. The CR oscillator clock has an oscillation time of between several μs and several ms.

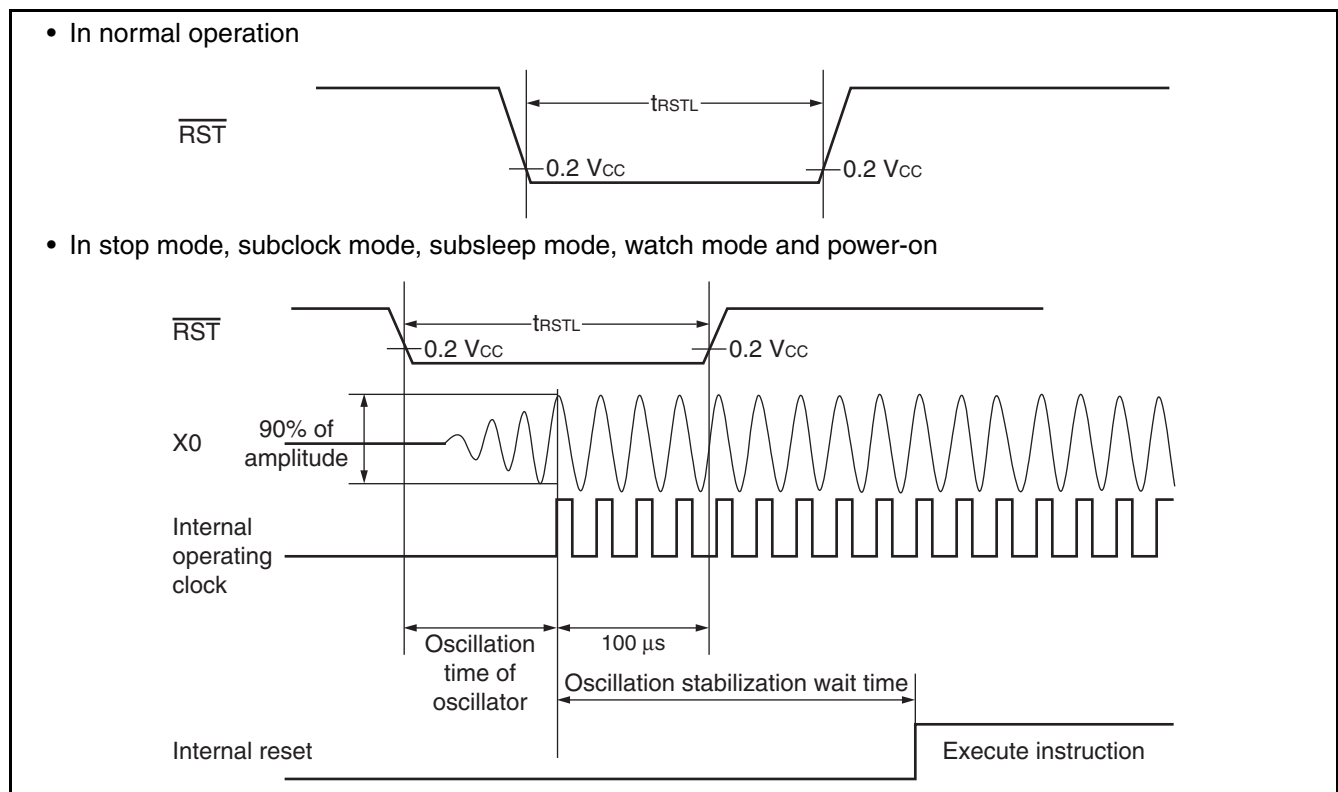

MB95220H Series

(4) Power-on Reset

($V_{SS} = 0.0 \text{ V}$, $T_A = -40^\circ\text{C}$ to $+85^\circ\text{C}$)

Parameter	Symbol	Condition	Value		Unit	Remarks
			Min	Max		
Power supply rising time	t_R	—	—	50	ms	
Power supply cutoff time	t_{OFF}	—	1	—	ms	Wait time until power-on

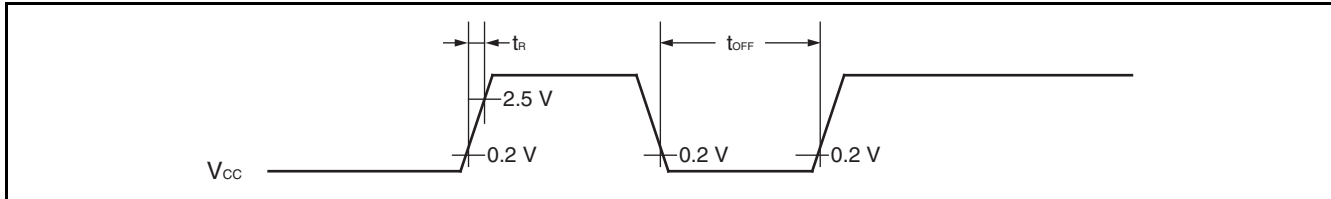

Note: A sudden change of power supply voltage may activate the power-on reset function. When changing the power supply voltage during the operation, set the slope of rising to a value below within 30 mV/ms as shown below.

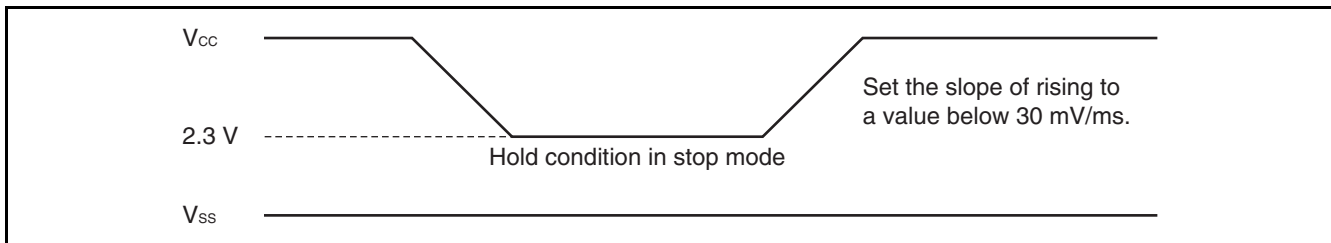

(5) Peripheral Input Timing

($V_{CC} = 5.0\text{ V} \pm 10\%$, $V_{SS} = 0.0\text{ V}$, $T_A = -40^\circ\text{C}$ to $+85^\circ\text{C}$)

Parameter	Symbol	Pin name	Value		Unit
			Min	Max	
Peripheral input "H" pulse width	t_{LH}	INT02 to INT07, EC0	$2 t_{MCLK}^*$	—	ns
Peripheral input "L" pulse width	t_{HL}		$2 t_{MCLK}^*$	—	ns

* See "(2) Source Clock/Machine Clock" for t_{MCLK} .

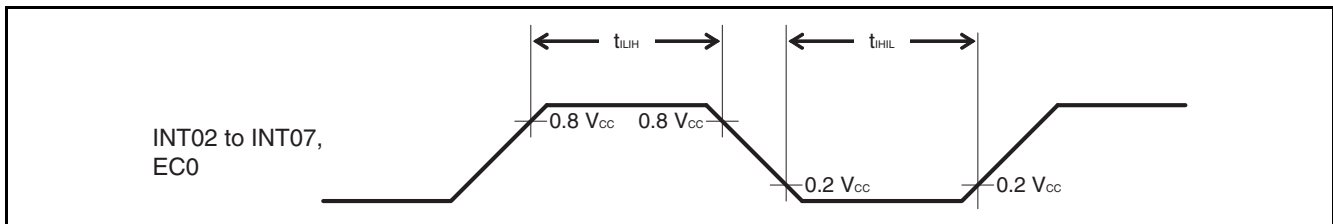

MB95220H Series

(6) LIN-UART Timing (Available only in MB95F222H/F222K/F223H/F223K)

Sampling is executed at the rising edge of the sampling clock*¹, and serial clock delay is disabled*².
(ESCR register:SCES bit = 0, ECCR register:SCDE bit = 0)

(V_{CC} = 5.0 V±10%, AV_{SS} = V_{SS} = 0.0 V, T_A = -40°C to +85°C)

Parameter	Symbol	Pin name	Condition	Value		Unit
				Min	Max	
Serial clock cycle time	t _{SCYC}	SCK	Internal clock operation output pin: C _L = 80 pF+1 TTL	5 t _{MCLK} * ³	—	ns
SCK ↓→ SOT delay time	t _{SLOVI}	SCK, SOT		-95	+95	ns
Valid SIN → SCK ↑	t _{IVSHI}	SCK, SIN		t _{MCLK} * ³ +190	—	ns
SCK ↑→ valid SIN hold time	t _{SHIXI}	SCK, SIN		0	—	ns
Serial clock “L” pulse width	t _{SLSH}	SCK	External clock operation output pin: C _L = 80 pF+1 TTL	3 t _{MCLK} * ³ -t _R	—	ns
Serial clock “H” pulse width	t _{SHSL}	SCK		t _{MCLK} * ³ +95	—	ns
SCK ↓→ SOT delay time	t _{SLOVE}	SCK, SOT		—	2 t _{MCLK} * ³ +95	ns
Valid SIN → SCK ↑	t _{IVSHE}	SCK, SIN		190	—	ns
SCK ↑→ valid SIN hold time	t _{SHIXE}	SCK, SIN		t _{MCLK} * ³ +95	—	ns
SCK fall time	t _F	SCK		—	10	ns
SCK rise time	t _R	SCK		—	10	ns

*1: There is a function used to choose whether the sampling of reception data is performed at a rising edge or a falling edge of the serial clock.

*2: The serial clock delay function is a function used to delay the output signal of the serial clock for half the clock.

*3: See “(2) Source Clock/Machine Clock” for t_{MCLK}.

- Internal shift clock mode

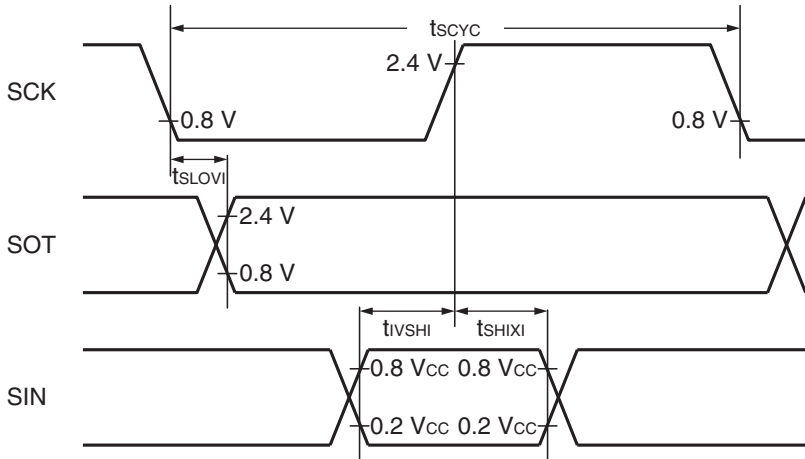

- External shift clock mode

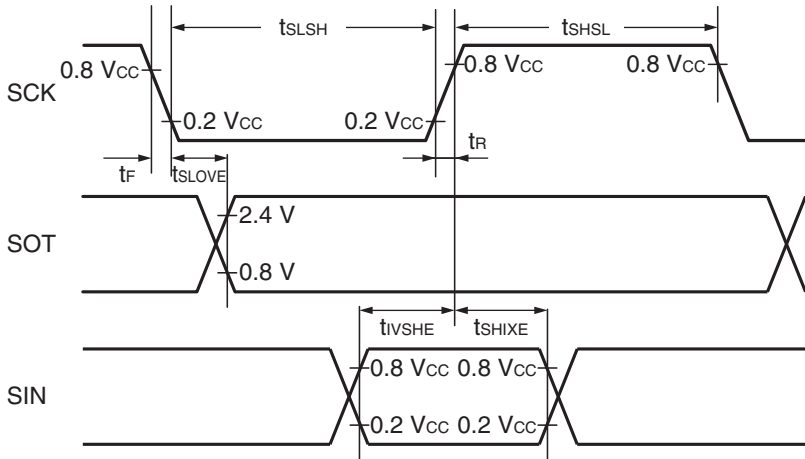

MB95220H Series

Sampling is executed at the falling edge of the sampling clock*¹, and serial clock delay is disabled*².
(ESCR register:SCES bit = 1, ECCR register:SCDE bit = 0)

(V_{CC} = 5.0 V±10%, V_{SS} = 0.0 V, T_A = -40°C to +85°C)

Parameter	Symbol	Pin name	Condition	Value		Unit
				Min	Max	
Serial clock cycle time	t _{SCYC}	SCK	Internal clock operation output pin: C _L = 80 pF+1 TTL	5 t _{MCLK} * ³	—	ns
SCK ↑→ SOT delay time	t _{SHOVI}	SCK, SOT		-95	+95	ns
Valid SIN → SCK ↓	t _{IVSLI}	SCK, SIN		t _{MCLK} * ³ +190	—	ns
SCK ↓→ valid SIN hold time	t _{SLIXI}	SCK, SIN		0	—	ns
Serial clock “H” pulse width	t _{SHSL}	SCK	External clock operation output pin: C _L = 80 pF+1 TTL	3 t _{MCLK} * ³ -t _R	—	ns
Serial clock “L” pulse width	t _{SLSH}	SCK		t _{MCLK} * ³ +95	—	ns
SCK ↑→ SOT delay time	t _{SHOVE}	SCK, SOT		—	2 t _{MCLK} * ³ +95	ns
Valid SIN → SCK ↓	t _{IVSLE}	SCK, SIN		190	—	ns
SCK ↓→ valid SIN hold time	t _{SLIXE}	SCK, SIN		t _{MCLK} * ³ +95	—	ns
SCK fall time	t _F	SCK		—	10	ns
SCK rise time	t _R	SCK		—	10	ns

*1: There is a function used to choose whether the sampling of reception data is performed at a rising edge or a falling edge of the serial clock.

*2: The serial clock delay function is a function used to delay the output signal of the serial clock for half the clock.

*3: See “(2) Source Clock/Machine Clock” for t_{MCLK}.

- Internal shift clock mode

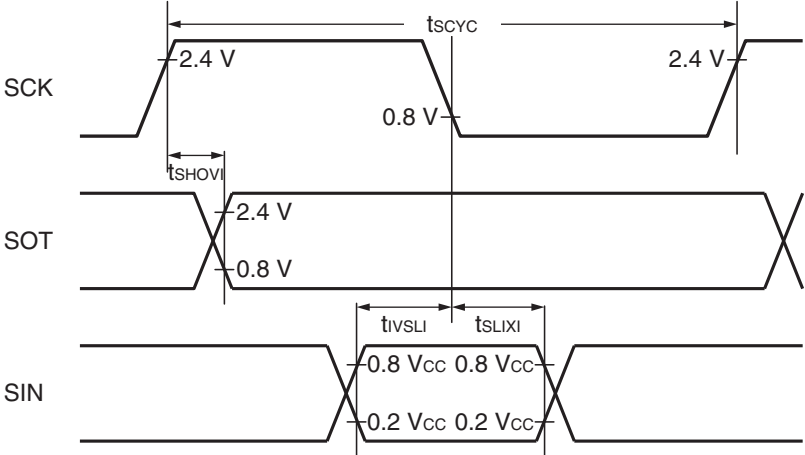

- External shift clock mode

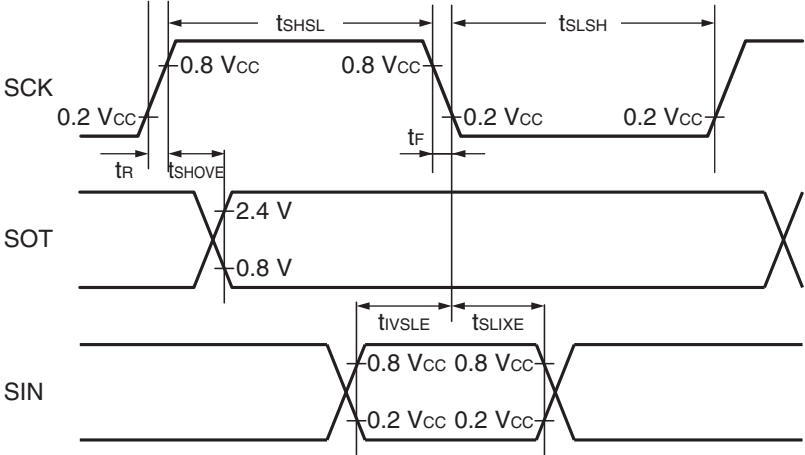

MB95220H Series

Sampling is executed at the rising edge of the sampling clock*¹, and serial clock delay is enabled*².
 (ESCR register:SCES bit = 0, ECCR register:SCDE bit = 1)

($V_{CC} = 5.0 V \pm 10\%$, $V_{SS} = 0.0 V$, $T_A = -40^\circ C$ to $+85^\circ C$)

Parameter	Symbol	Pin name	Condition	Value		Unit
				Min	Max	
Serial clock cycle time	t_{SCYC}	SCK	Internal clock operation output pin: $C_L = 80 pF + 1 TTL$	$5 t_{MCLK}^{*3}$	—	ns
SCK $\uparrow \rightarrow$ SOT delay time	t_{SHOVI}	SCK, SOT		-95	+95	ns
Valid SIN \rightarrow SCK \downarrow	t_{VSLI}	SCK, SIN		$t_{MCLK}^{*3} + 190$	—	ns
SCK $\downarrow \rightarrow$ valid SIN hold time	t_{SLIXI}	SCK, SIN		0	—	ns
SOT \rightarrow SCK \downarrow delay time	t_{SOVLI}	SCK, SOT		—	$4 t_{MCLK}^{*3}$	ns

*1: There is a function used to choose whether the sampling of reception data is performed at a rising edge or a falling edge of the serial clock.

*2: The serial clock delay function is a function that delays the output signal of the serial clock for half clock.

*3: See “(2) Source Clock/Machine Clock” for t_{MCLK} .

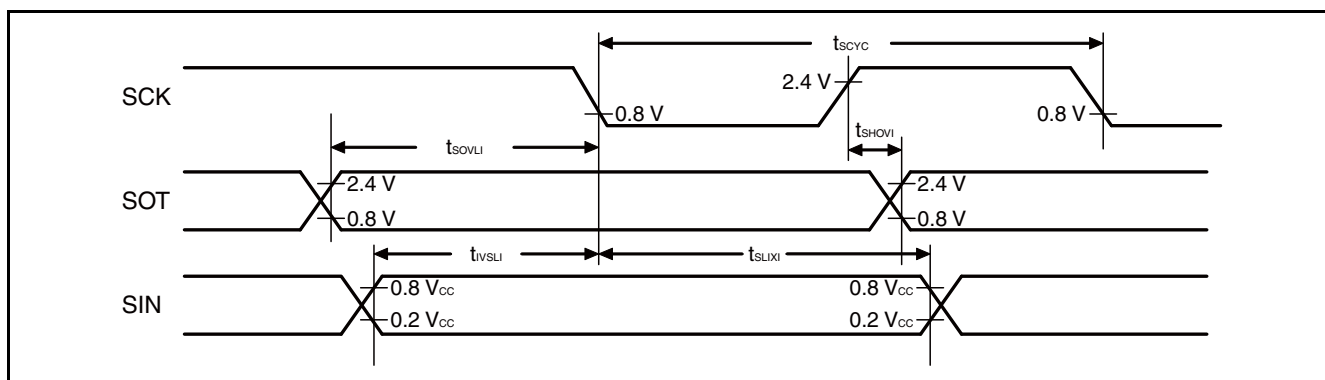

Sampling is executed at the falling edge of the sampling clock*¹, and serial clock delay is enabled*².
 (ESCR register:SCES bit = 1, ECCR register:SCDE bit = 1)

($V_{CC} = 5.0 V \pm 10\%$, $V_{SS} = 0.0 V$, $T_A = -40^\circ C$ to $+85^\circ C$)

Parameter	Symbol	Pin name	Condition	Value		Unit
				Min	Max	
Serial clock cycle time	t_{SCYC}	SCK	Internal clock operation output pin: $C_L = 80 pF + 1 TTL$	$5 t_{MCLK}^{*3}$	—	ns
SCK ↓ → SOT delay time	t_{SLOVI}	SCK, SOT		-95	+95	ns
Valid SIN → SCK ↑	t_{VSHI}	SCK, SIN		$t_{MCLK}^{*3} + 190$	—	ns
SCK ↑ → valid SIN hold time	t_{SHIXI}	SCK, SIN		0	—	ns
SOT → SCK ↑ delay time	t_{SOVHI}	SCK, SOT		—	$4 t_{MCLK}^{*3}$	ns

*1: There is a function used to choose whether the sampling of reception data is performed at a rising edge or a falling edge of the serial clock.

*2: The serial clock delay function is a function that delays the output signal of the serial clock for half clock.

*3: See “(2) Source Clock/Machine Clock” for t_{MCLK} .

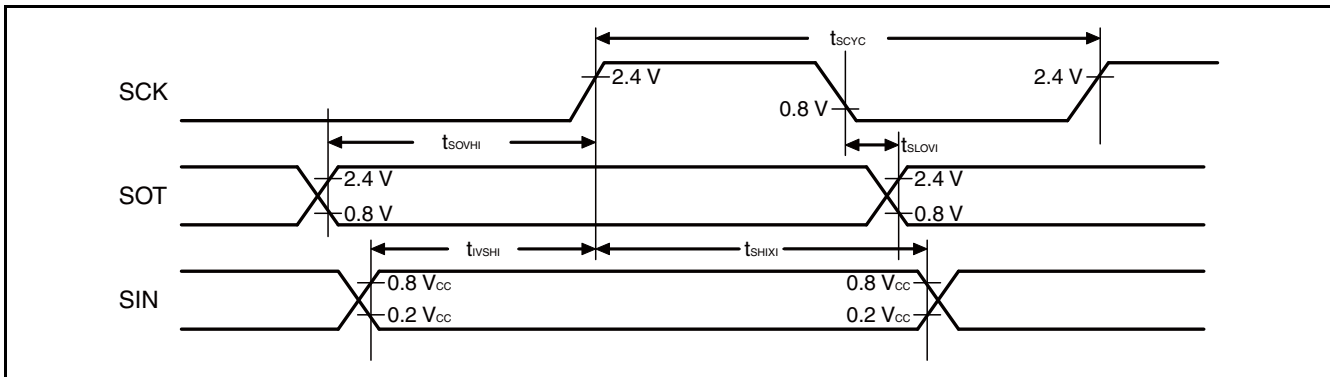

MB95220H Series

(7) Low-voltage Detection

($V_{SS} = 0.0\text{ V}$, $T_A = -40^\circ\text{C}$ to $+85^\circ\text{C}$)

Parameter	Symbol	Value			Unit	Remarks
		Min	Typ	Max		
Release voltage	V_{DL+}	2.52	2.7	2.88	V	At power supply rise
Detection voltage	V_{DL-}	2.42	2.6	2.78	V	At power supply fall
Hysteresis width	V_{HYS}	70	100	—	mV	
Power supply start voltage	V_{off}	—	—	2.3	V	
Power supply end voltage	V_{on}	4.9	—	—	V	
Power supply voltage change time (at power supply rise)	t_r	1	—	—	μs	Slope of power supply that the reset release signal generates
		—	3000	—	μs	Slope of power supply that the reset release signal generates within the rating (V_{DL+})
Power supply voltage change time (at power supply fall)	t_r	300	—	—	μs	Slope of power supply that the reset detection signal generates
		—	300	—	μs	Slope of power supply that the reset detection signal generates within the rating (V_{DL-})
Reset release delay time	t_{d1}	—	—	300	μs	
Reset detection delay time	t_{d2}	—	—	20	μs	

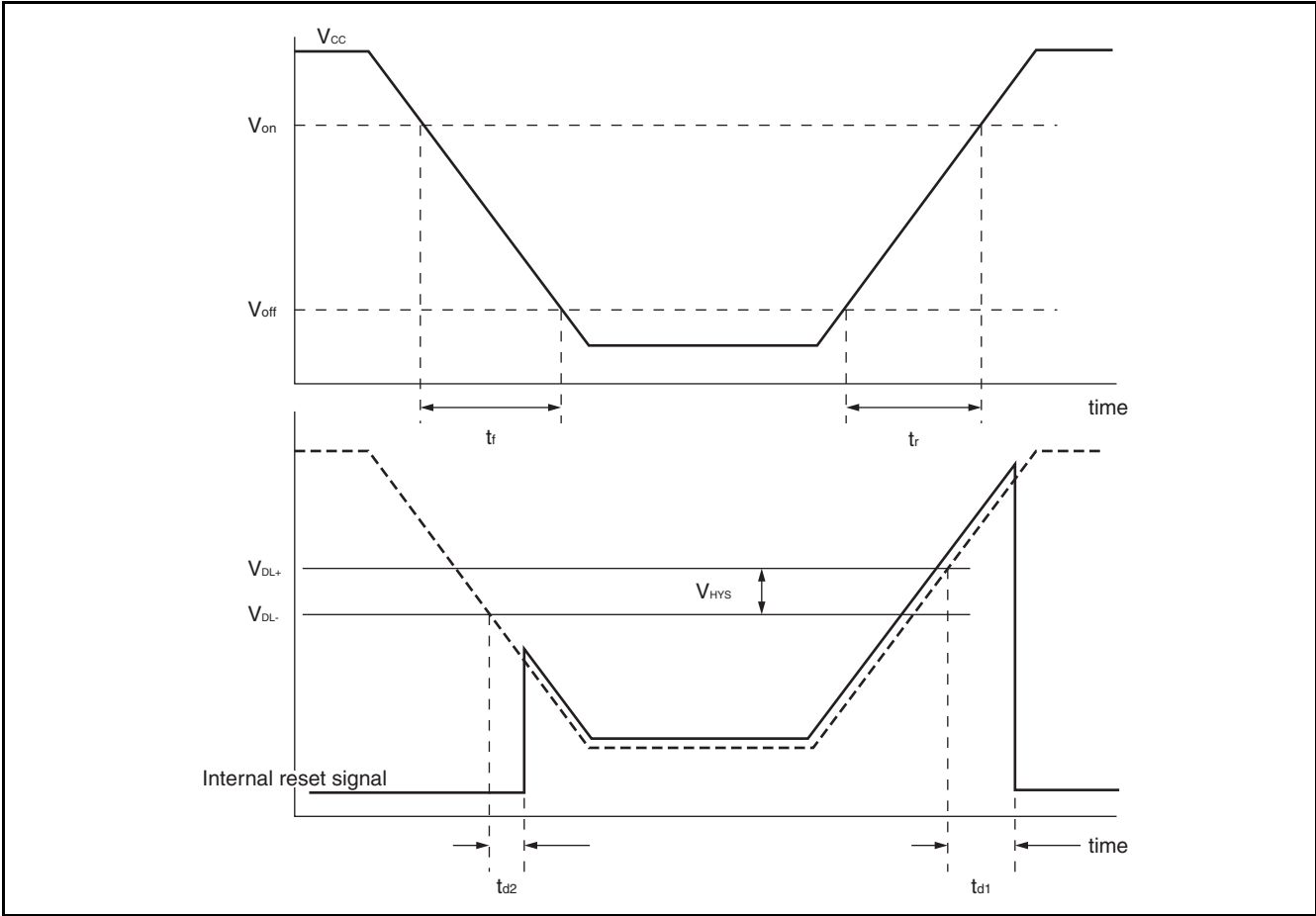

MB95220H Series

5. A/D Converter

(1) A/D Converter Electrical Characteristics

($V_{CC} = 4.0\text{ V to }5.5\text{ V}$, $V_{SS} = 0.0\text{ V}$, $T_A = -40^\circ\text{C to }+85^\circ\text{C}$)

Parameter	Symbol	Value			Unit	Remarks
		Min	Typ	Max		
Resolution	—	—	—	10	bit	
Total error		-3	—	+3	LSB	
Linearity error		-2.5	—	+2.5	LSB	
Differential linear error		-1.9	—	+1.9	LSB	
Zero transition voltage	V_{OT}	$V_{SS}-1.5\text{ LSB}$	$V_{SS}+0.5\text{ LSB}$	$V_{SS}+2.5\text{ LSB}$	V	
Full-scale transition voltage	V_{FST}	$V_{CC}-4.5\text{ LSB}$	$V_{CC}-2\text{ LSB}$	$V_{CC}+0.5\text{ LSB}$	V	
Compare time	—	0.9	—	16500	μs	$4.5\text{ V} \leq V_{CC} \leq 5.5\text{ V}$
		1.8	—	16500	μs	$4.0\text{ V} \leq V_{CC} < 4.5\text{ V}$
Sampling time	—	0.6	—	∞	μs	$4.5\text{ V} \leq V_{CC} \leq 5.5\text{ V}$, with external impedance $< 5.4\text{ k}\Omega$
		1.2	—	∞	μs	$4.0\text{ V} \leq V_{CC} \leq 4.5\text{ V}$, with external impedance $< 2.4\text{ k}\Omega$
Analog input current	I_{AIN}	-0.3	—	+0.3	μA	
Analog input voltage	V_{AIN}	V_{SS}	—	V_{CC}	V	

(2) Notes on Using the A/D Converter

• External impedance of analog input and its sampling time

- The A/D converter has a sample and hold circuit. If the external impedance is too high to keep sufficient sampling time, the analog voltage charged to the capacitor of the internal sample and hold circuit is insufficient, adversely affecting A/D conversion precision. Therefore, to satisfy the A/D conversion precision standard, considering the relationship between the external impedance and minimum sampling time, either adjust the register value and operating frequency or decrease the external impedance so that the sampling time is longer than the minimum value. In addition, if sufficient sampling time cannot be secured, connect a capacitor of about 0.1 μF to the analog input pin.

• Analog input equivalent circuit

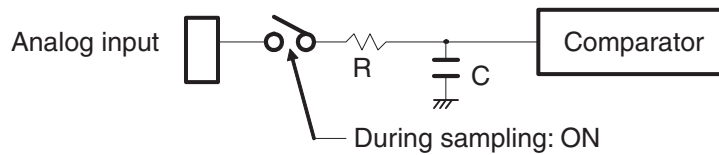

$$4.5 \text{ V} \leq V_{\text{CC}} \leq 5.5 \text{ V} : R \approx 1.95 \text{ k}\Omega \text{ (Max)}, C \approx 17 \text{ pF (Max)}$$

$$4.0 \text{ V} \leq V_{\text{CC}} < 4.5 \text{ V} : R \approx 8.98 \text{ k}\Omega \text{ (Max)}, C \approx 17 \text{ pF (Max)}$$

Note: The values are reference values.

• Relationship between external impedance and minimum sampling time

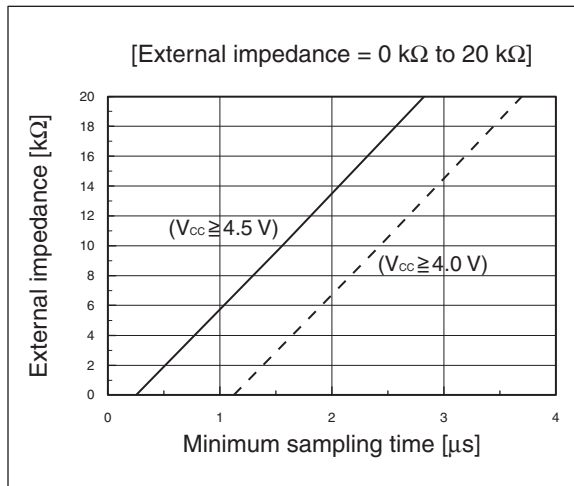
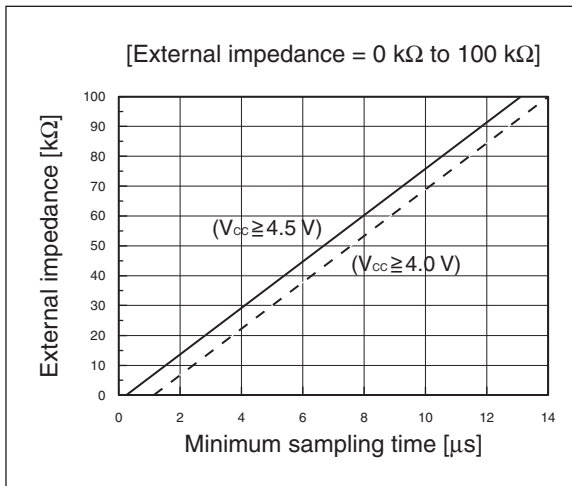

• A/D conversion error

As $|V_{\text{CC}} - V_{\text{SS}}|$ decreases, the A/D conversion error increases proportionately.

MB95220H Series

(3) Definitions of A/D Converter Terms

- Resolution

It indicates the level of analog variation that can be distinguished by the A/D converter. When the number of bits is 10, analog voltage can be divided into $2^{10} = 1024$.

- Linearity error (unit: LSB)

It indicates how much an actual conversion value deviates from the straight line connecting the zero transition point (“00 0000 0000” \leftrightarrow “00 0000 0001”) of a device to the full-scale transition point (“11 1111 1111” \leftrightarrow “11 1111 1110”) of the same device.

- Differential linear error (unit : LSB)

It indicates how much the input voltage required to change the output code by 1 LSB deviates from an ideal value.

- Total error (unit: LSB)

It indicates the difference between an actual value and a theoretical value. The error can be caused by a zero transition error, a full-scale transition errors, a linearity error, a quantum error, or noise.

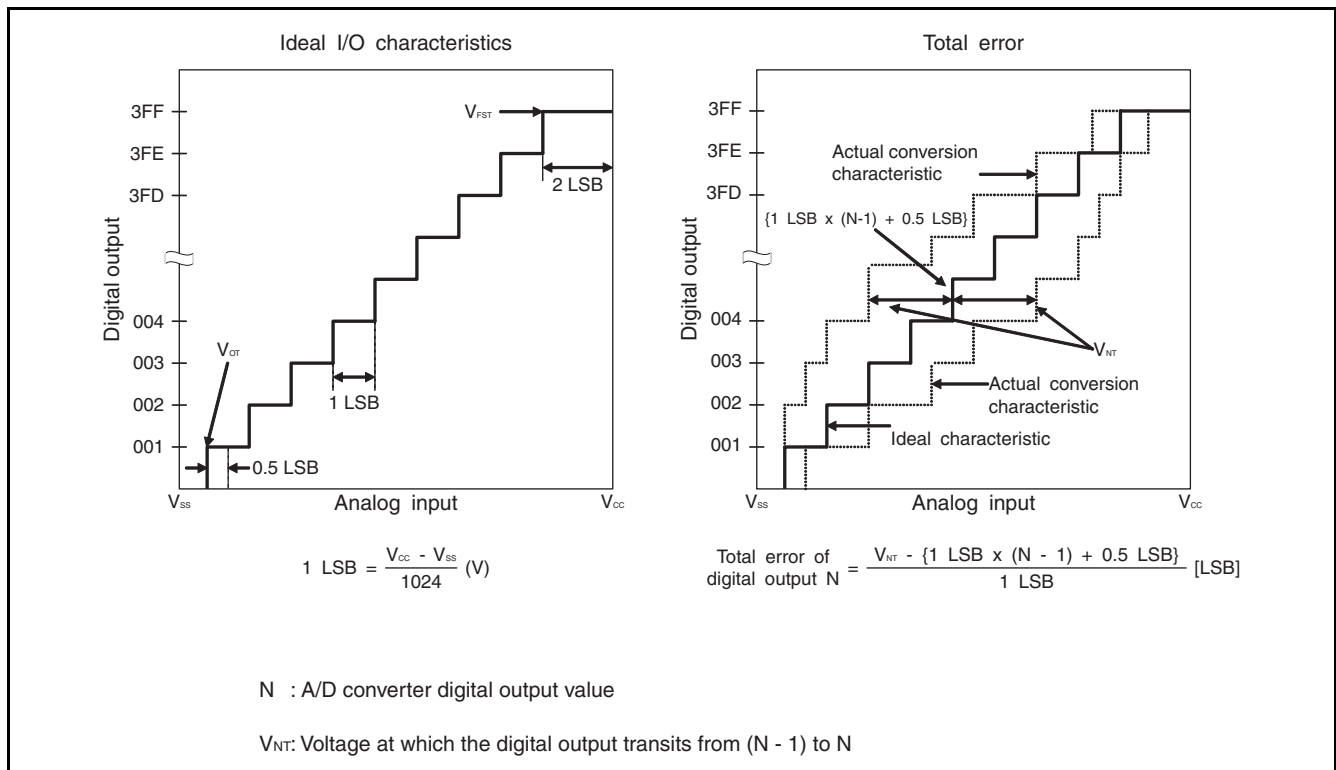

(Continued)

(Continued)

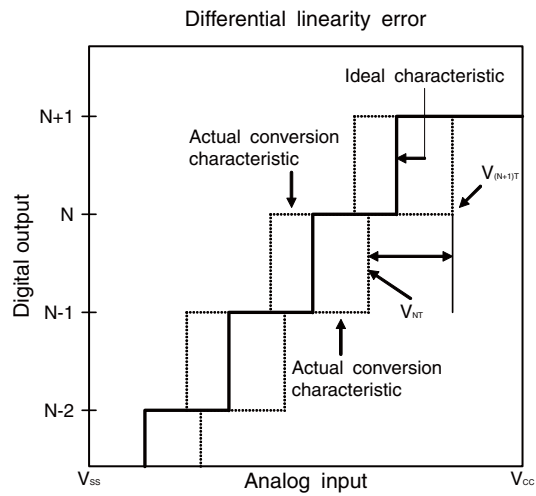
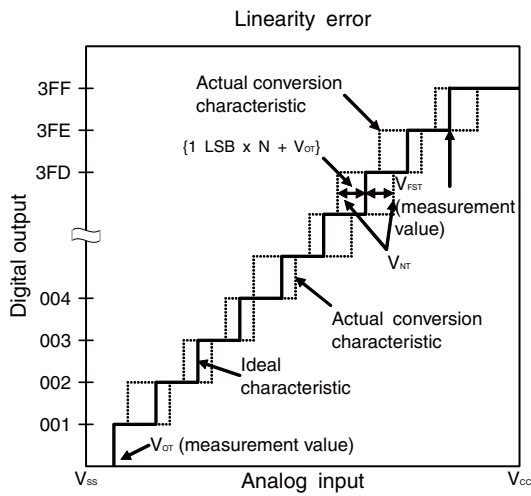
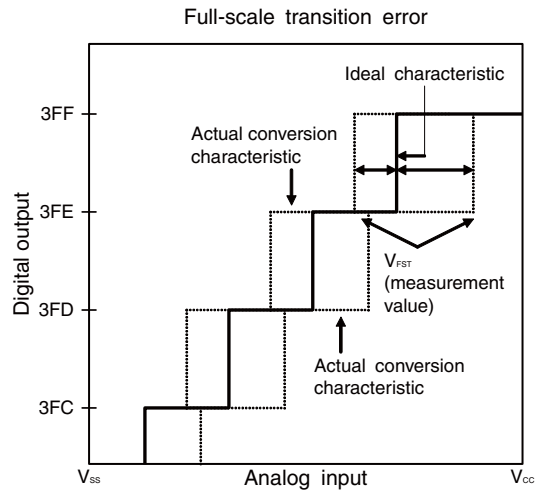
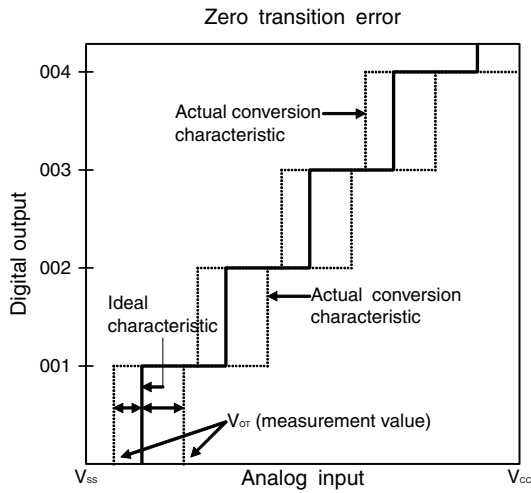

$$\text{Linearity error of digital output } N = \frac{V_{NT} - \{1 \text{ LSB} \times N + V_{OT}\}}{1 \text{ LSB}}$$

$$\text{Differential linear error of digital output } N = \frac{V_{(N+1)T} - V_{NT}}{1 \text{ LSB}} - 1$$

N : A/D converter digital output value

V_{NT}: Voltage at which the digital output transits from (N - 1) to N

V_{OT} (ideal value) = V_{SS} + 0.5 LSB [V]

V_{FST} (ideal value) = V_{CC} - 2 LSB [V]

MB95220H Series

6. Flash Memory Program/Erase Characteristics

Parameter	Value			Unit	Remarks
	Min	Typ	Max		
Chip erase time	—	1*1	15*2	s	00H programming time prior to erasure is excluded.
Byte programming time	—	32	3600	μs	System-level overhead is excluded.
Erase/program voltage	9.5	10	10.5	V	The erase/program voltage must be applied to the PF2 pin in erase/program.
Current drawn on PF2	—	—	5.0	mA	Current consumption of PF2 pin during flash memory program/erase
Erase/program cycle	—	100000	—	cycle	
Power supply voltage at erase/program	3.0	—	5.5	V	
Flash memory data retention time	20*3	—	—	year	Average T _A = +85°C

*1: T_A = +25°C, V_{CC} = 5.0 V, 100000 cycles

*2: T_A = +85°C, V_{CC} = 4.5 V, 100000 cycles

*3: This value is converted from the result of a technology reliability assessment. (The value is converted from the result of a high temperature accelerated test by using the Arrhenius equation with the average temperature being +85°C).

■ SAMPLE ELECTRICAL CHARACTERISTICS

- Power supply current • temperature

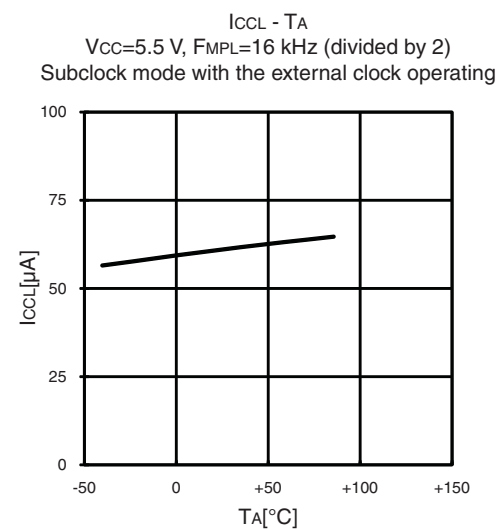
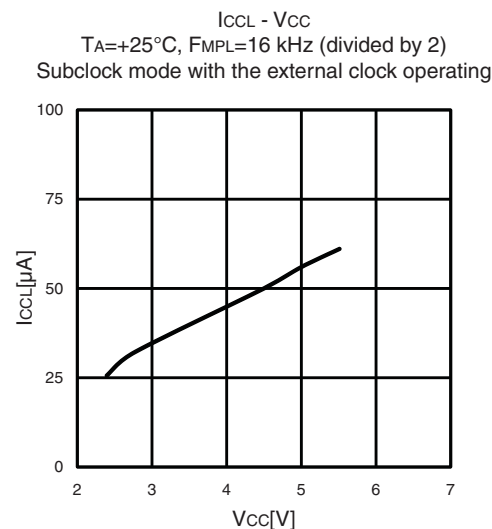
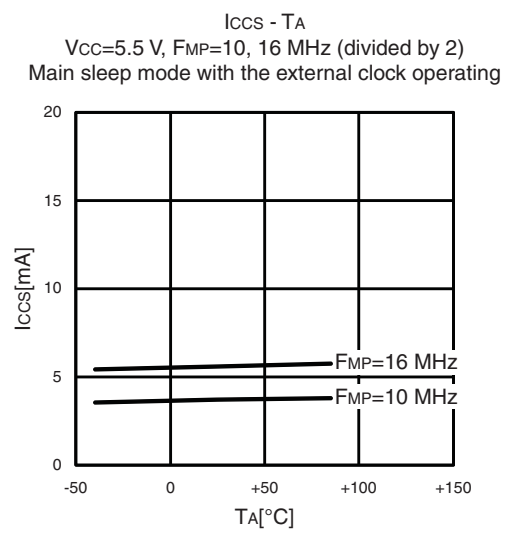
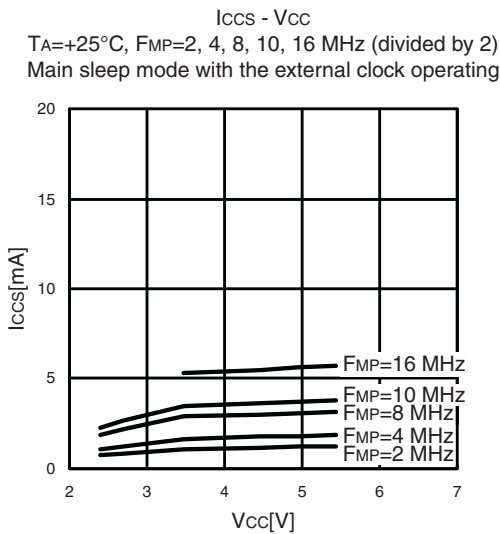
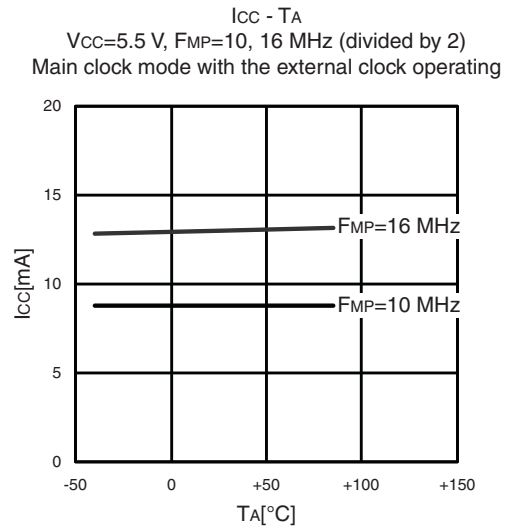
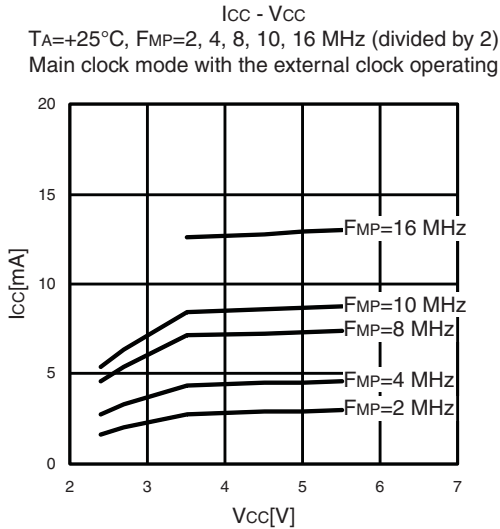

(Continued)

MB95220H Series

ICCLS - VCC
 $T_A = +25^\circ\text{C}$, $F_{MPL} = 16\text{ kHz}$ (divided by 2)
 Subsleeper mode with the external clock operating

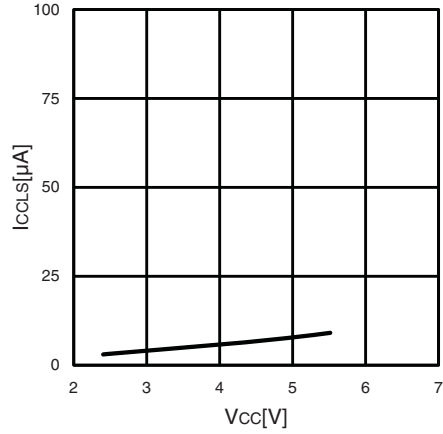

ICCLS - TA
 $V_{CC} = 5.5\text{ V}$, $F_{MPL} = 16\text{ kHz}$ (divided by 2)
 Subsleeper mode with the external clock operating

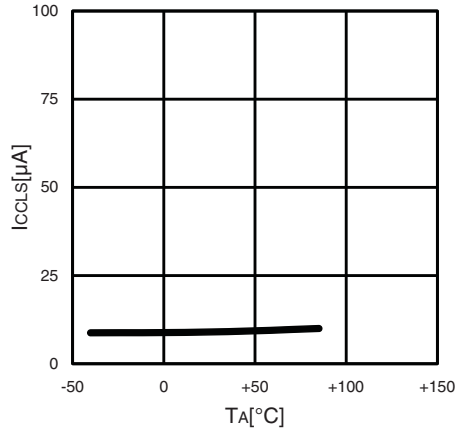

ICCT - VCC
 $T_A = +25^\circ\text{C}$, $F_{MPL} = 16\text{ kHz}$ (divided by 2)
 Clock mode with the external clock operating

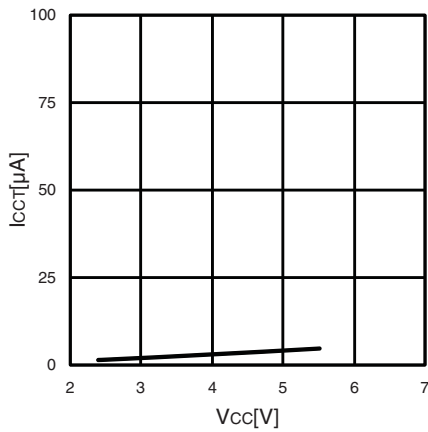

ICCT - TA
 $V = 5.5\text{ V}$, $F_{MPL} = 16\text{ kHz}$ (divided by 2)
 Clock mode with the external clock operating

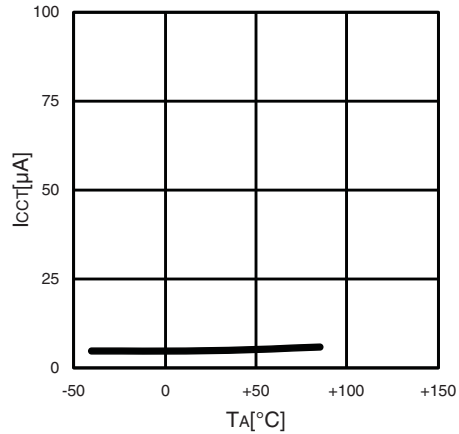

ICTS - VCC
 $T_A = +25^\circ\text{C}$, $F_{MP} = 2, 4, 8, 10, 16\text{ MHz}$ (divided by 2)
 Timebase timer mode with the external clock operating

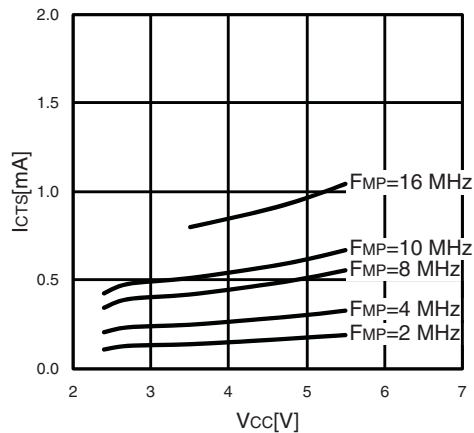

ICTS - TA
 $V = 5.5\text{ V}$, $F_{MP} = 10, 16\text{ MHz}$ (divided by 2)
 Timebase timer mode with the external clock operating

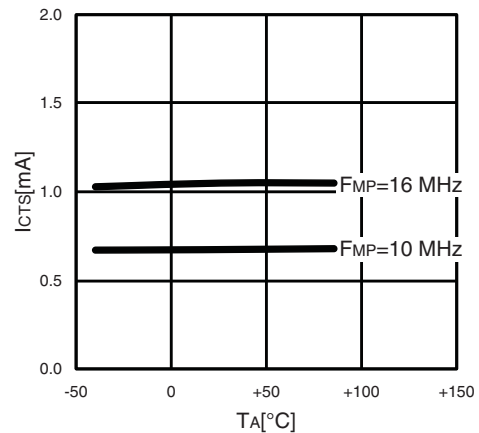

(Continued)

(Continued)

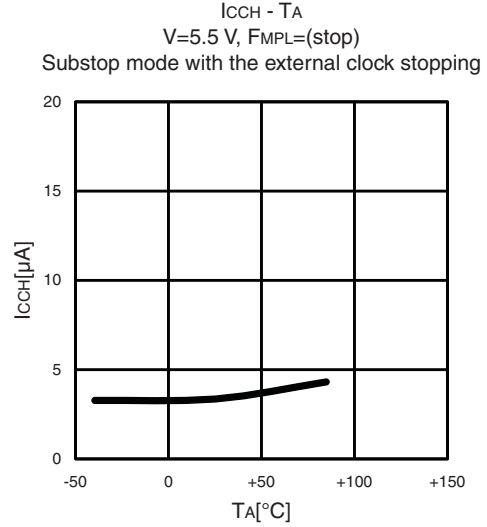
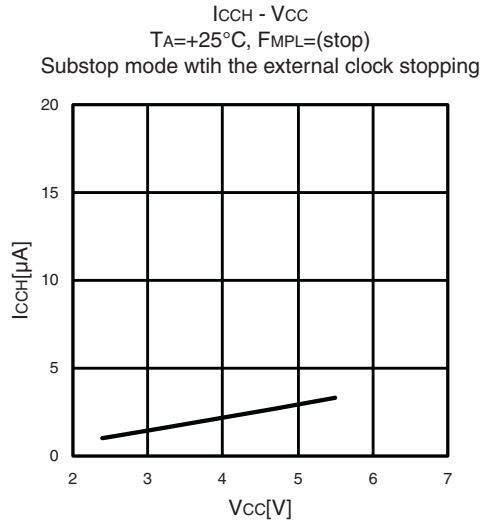

I_{CC}MCR - V_{CC}
 T_A=+25°C, F_{MPL}=1, 8, 10 MHz (no division)
 Main clock mode with the internal main CR clock operating

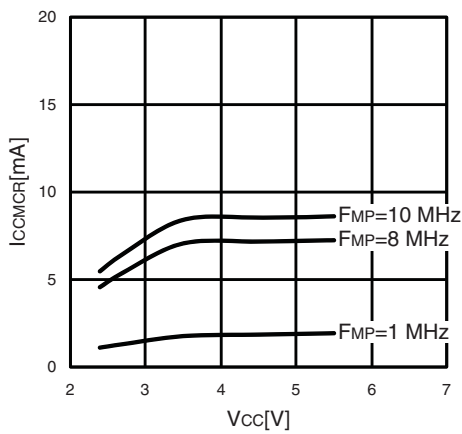

I_{CC}MCR - T_A
 V=5.5 V, F_{MPL}=1, 8, 10 MHz (no division)
 Main clock mode with the internal main CR clock operating

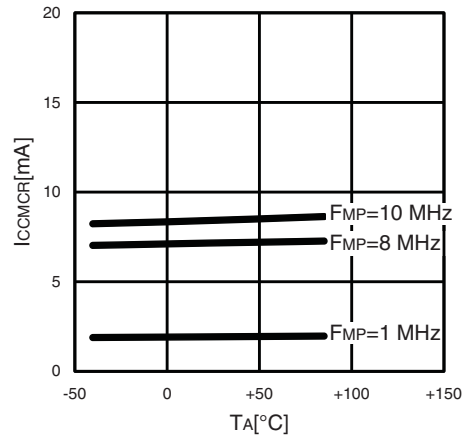

I_{CC}SCR - V_{CC}
 T_A=+25°C, F_{MPL}=50 kHz (divided by 2)
 Subclock mode with the internal sub-CR clock operating

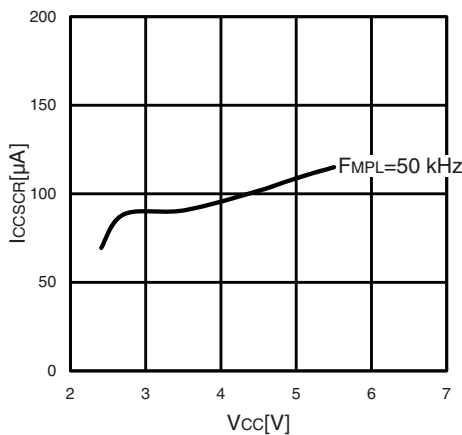

I_{CC}SCR - T_A
 V_{CC}=5.5 V, F_{MPL}=50 kHz (divided by 2)
 Subclock mode with the internal sub-CR clock operating

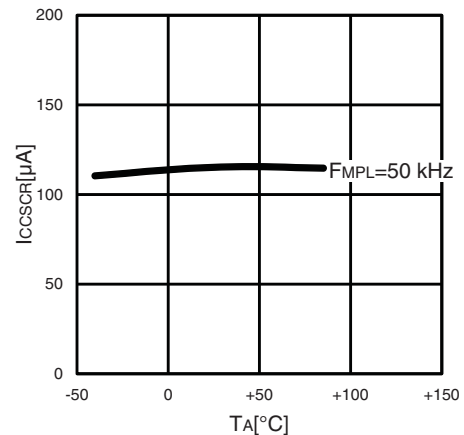

MB95220H Series

- Input voltage

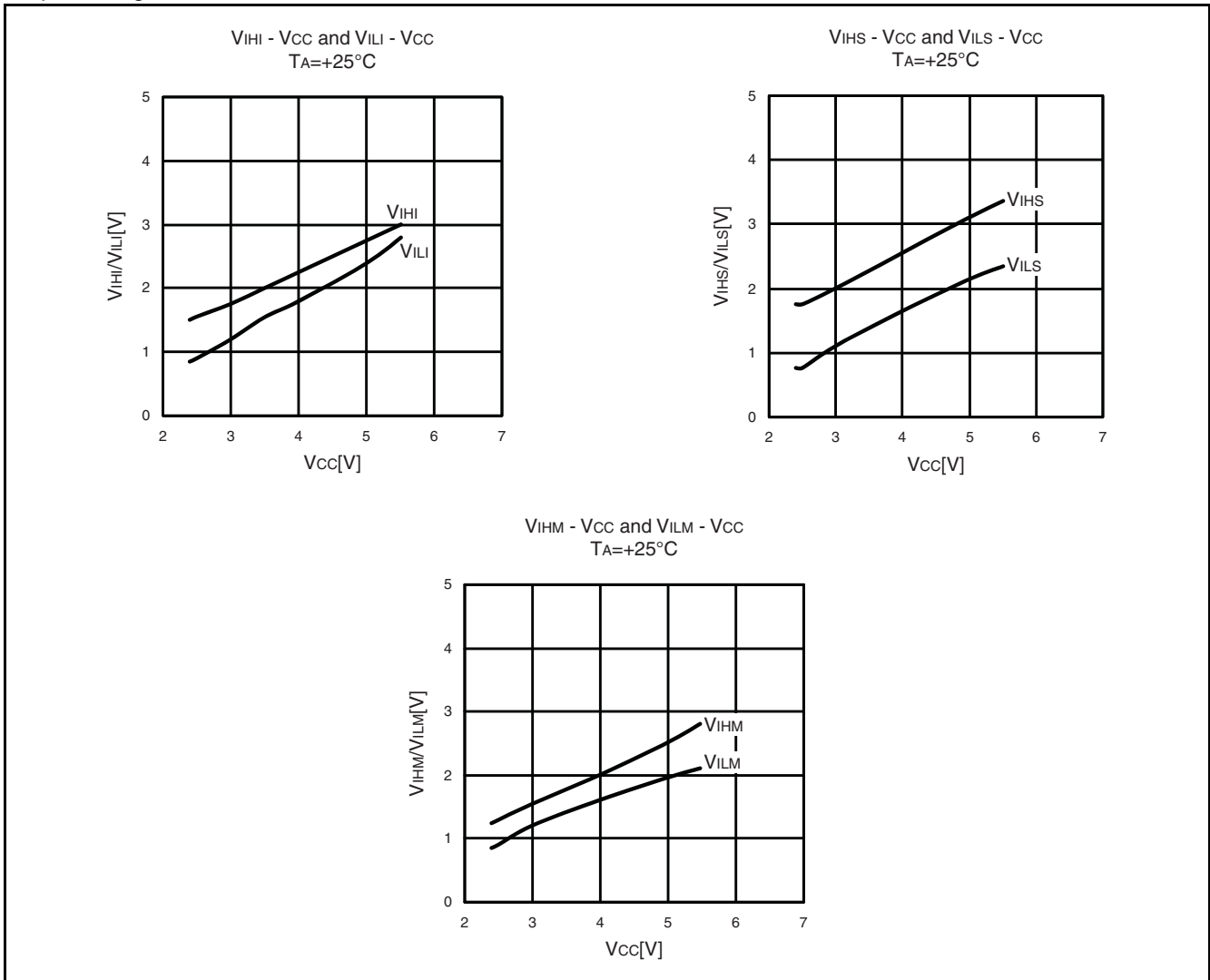

• Output voltage

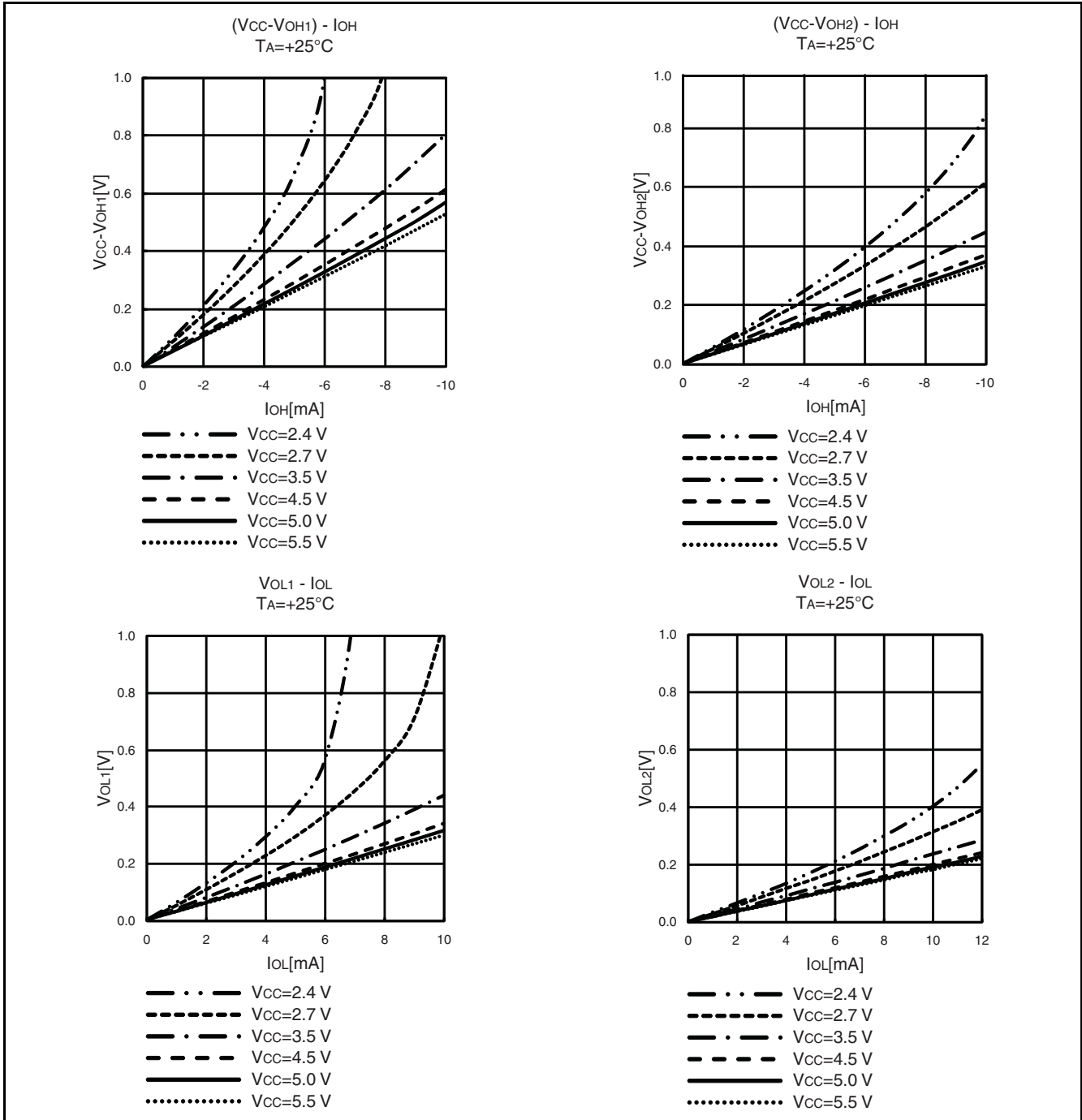

MB95220H Series

- Pull-up

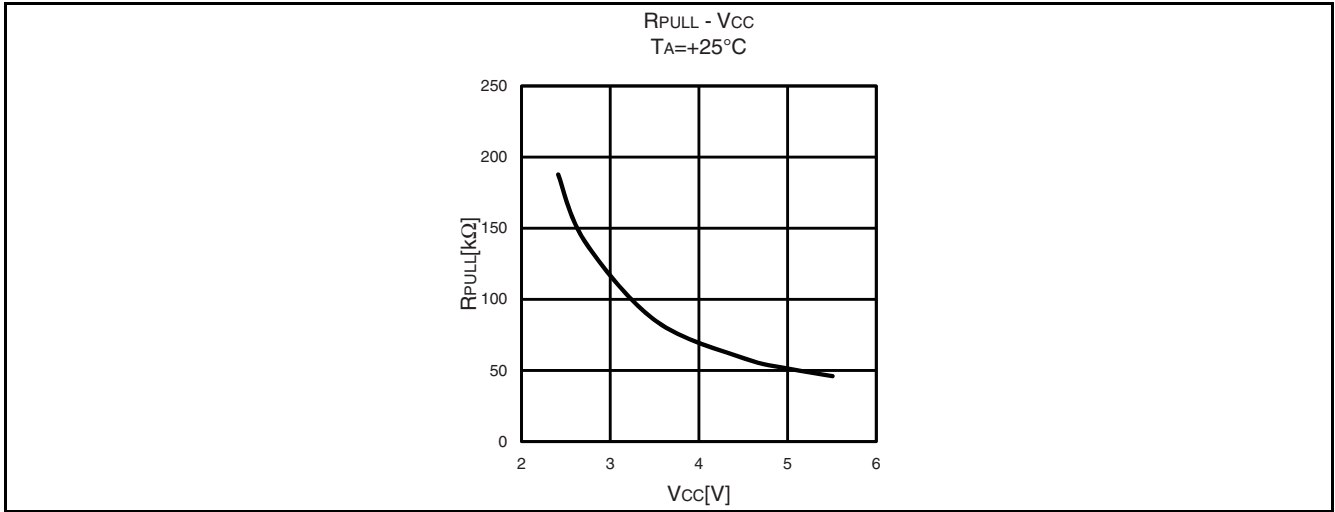

■ MASK OPTIONS

No.	Part Number	MB95F222H MB95F223H	MB95F222K MB95F223K
	Selectable/Fixed	Fixed	Fixed
1	Low-voltage detection reset <ul style="list-style-type: none"> • With low-voltage detection reset • Without low-voltage detection reset 	Without low-voltage detection reset	With low-voltage detection reset
2	Reset <ul style="list-style-type: none"> • With dedicated reset input • Without dedicated reset input 	With dedicated reset input	Without dedicated reset input

■ ORDERING INFORMATION

Part Number	Package
MB95F222HPH-G-SNE2 MB95F222KPH-G-SNE2 MB95F223HPH-G-SNE2 MB95F223KPH-G-SNE2	16-pin plastic DIP (DIP-16P-M06)
MB95F222HPF-G-SNE1 MB95F222KPF-G-SNE1 MB95F223HPF-G-SNE1 MB95F223KPF-G-SNE1	16-pin plastic SOP (FPT-16P-M06)

MB95220H Series

■ PACKAGE DIMENSIONS

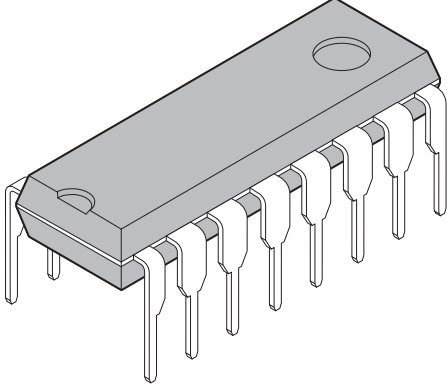
<p>16-pin plastic DIP</p>  <p>(DIP-16P-M06)</p>	Lead pitch	2.54 mm
	Sealing method	Plastic mold

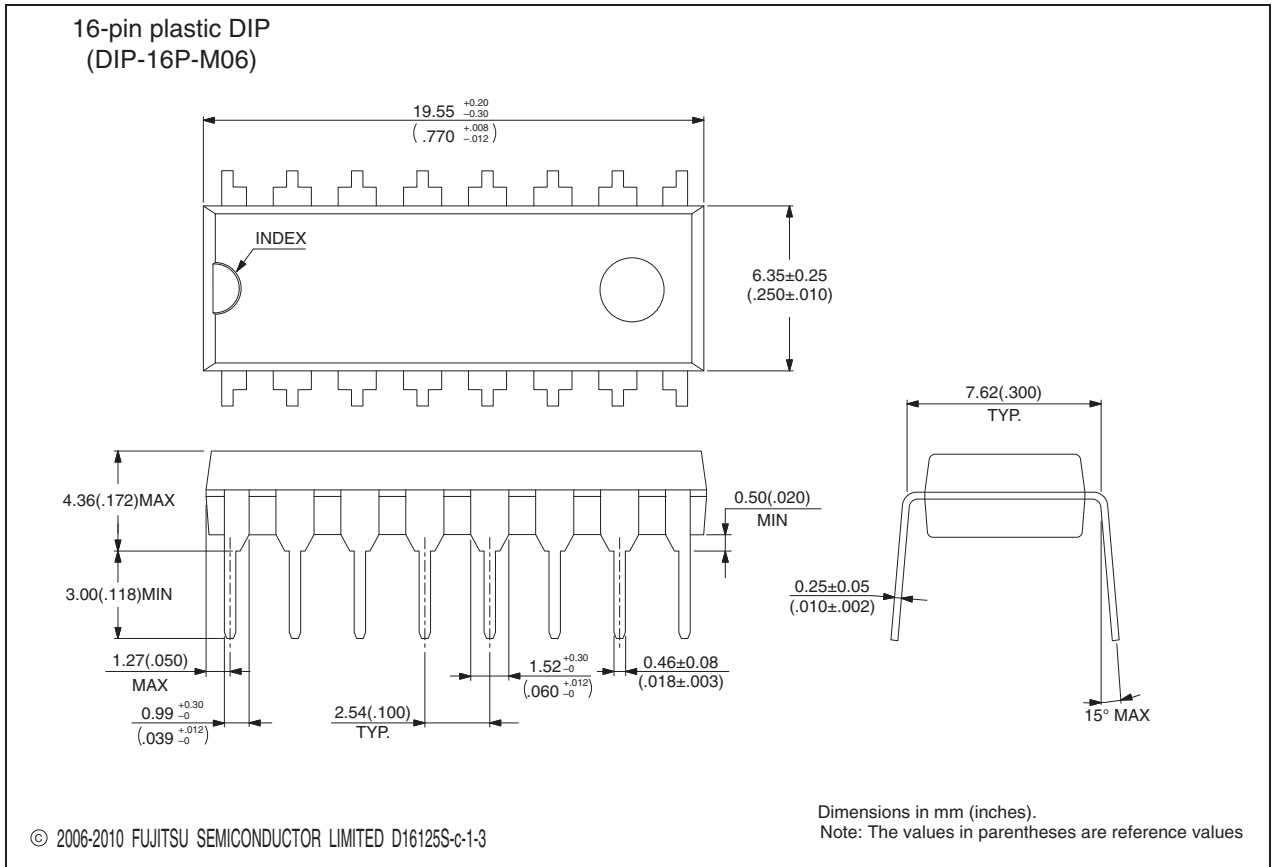

Please check the latest package dimension at the following URL.
<http://edevic.fujitsu.com/package/en-search/>

(Continued)

(Continued)

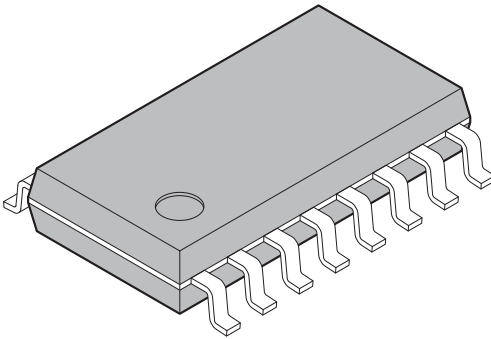
<p style="text-align: center;">16-pin plastic SOP</p>  <p style="text-align: center;">(FPT-16P-M06)</p>	Lead pitch	1.27 mm
	Package width × package length	5.3 × 10.15 mm
	Lead shape	Gullwing
	Sealing method	Plastic mold
	Mounting height	2.25 mm MAX
	Weight	0.20 g
	Code (Reference)	P-SOP16-5.3×10.15-1.27

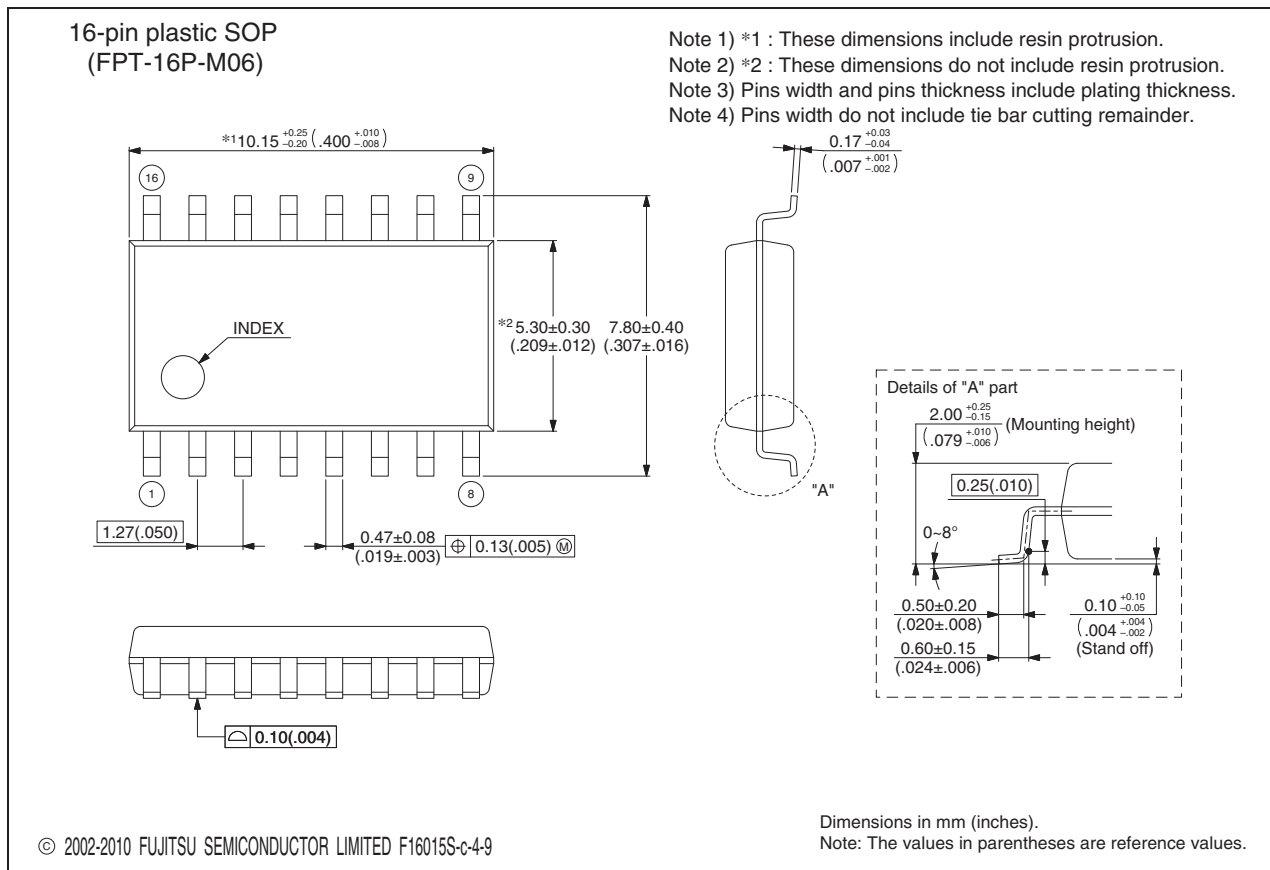

Please check the latest package dimension at the following URL.
<http://edevic.fujitsu.com/package/en-search/>

MB95220H Series

■ MAIN CHANGES IN THIS EDITION

Page	Section	Change Results
21	■ ELECTRICAL CHARACTERISTICS 1. Absolute Maximum Ratings	Changed the characteristics of Input voltage.
24	3. DC Characteristics	Corrected the maximum value of "H" level input voltage for PF2 pin. $V_{CC} + 0.3 \rightarrow 10.5$
		Corrected the maximum value of Open-drain output application voltage. $0.2V_{CC} \rightarrow V_{SS} + 5.5$
		Added the footnote *3.
26		
29	4. AC Characteristics (1) Clock Timing	Added a figure of HCLK1/HCLK2.
32	(2) Source Clock/Machine Clock	Corrected the graph of Operating voltage - Operating frequency (with the on-chip debug function). (Corrected the pitch)
33	(3) External Reset	Added and power on to the remarks column.
48	6. Flash Memory Program/ Erase Characteristics	Added the row of Current drawn on PF2.
		Corrected the minimum value of Power supply voltage at erase/program. $4.5 \rightarrow 3.0$

The vertical lines marked in the left side of the page show the changes.

MEMO

MB95220H Series

FUJITSU SEMICONDUCTOR LIMITED

Nomura Fudosan Shin-yokohama Bldg. 10-23, Shin-yokohama 2-Chome,

Kohoku-ku Yokohama Kanagawa 222-0033, Japan

Tel: +81-45-415-5858

<http://jp.fujitsu.com/fsl/en/>

For further information please contact:

North and South America

FUJITSU SEMICONDUCTOR AMERICA, INC.

1250 E. Arques Avenue, M/S 333

Sunnyvale, CA 94085-5401, U.S.A.

Tel: +1-408-737-5600 Fax: +1-408-737-5999

<http://us.fujitsu.com/micro/>

Asia Pacific

FUJITSU SEMICONDUCTOR ASIA PTE. LTD.

151 Lorong Chuan,

#05-08 New Tech Park 556741 Singapore

Tel : +65-6281-0770 Fax : +65-6281-0220

<http://www.fujitsu.com/sg/services/micro/semiconductor/>

Europe

FUJITSU SEMICONDUCTOR EUROPE GmbH

Pittlerstrasse 47, 63225 Langen, Germany

Tel: +49-6103-690-0 Fax: +49-6103-690-122

<http://emea.fujitsu.com/semiconductor/>

FUJITSU SEMICONDUCTOR SHANGHAI CO., LTD.

Rm. 3102, Bund Center, No.222 Yan An Road (E),

Shanghai 200002, China

Tel : +86-21-6146-3688 Fax : +86-21-6335-1605

<http://cn.fujitsu.com/fmc/>

Korea

FUJITSU SEMICONDUCTOR KOREA LTD.

206 Kosmo Tower Building, 1002 Daechi-Dong,

Gangnam-Gu, Seoul 135-280, Republic of Korea

Tel: +82-2-3484-7100 Fax: +82-2-3484-7111

<http://kr.fujitsu.com/fmk/>

FUJITSU SEMICONDUCTOR PACIFIC ASIA LTD.

10/F., World Commerce Centre, 11 Canton Road,

Tsimshatsui, Kowloon, Hong Kong

Tel : +852-2377-0226 Fax : +852-2376-3269

<http://cn.fujitsu.com/fmc/en/>

Specifications are subject to change without notice. For further information please contact each office.

All Rights Reserved.

The contents of this document are subject to change without notice.

Customers are advised to consult with sales representatives before ordering.

The information, such as descriptions of function and application circuit examples, in this document are presented solely for the purpose of reference to show examples of operations and uses of FUJITSU SEMICONDUCTOR device; FUJITSU SEMICONDUCTOR does not warrant proper operation of the device with respect to use based on such information. When you develop equipment incorporating the device based on such information, you must assume any responsibility arising out of such use of the information.

FUJITSU SEMICONDUCTOR assumes no liability for any damages whatsoever arising out of the use of the information.

Any information in this document, including descriptions of function and schematic diagrams, shall not be construed as license of the use or exercise of any intellectual property right, such as patent right or copyright, or any other right of FUJITSU SEMICONDUCTOR or any third party or does FUJITSU SEMICONDUCTOR warrant non-infringement of any third-party's intellectual property right or other right by using such information. FUJITSU SEMICONDUCTOR assumes no liability for any infringement of the intellectual property rights or other rights of third parties which would result from the use of information contained herein.

The products described in this document are designed, developed and manufactured as contemplated for general use, including without limitation, ordinary industrial use, general office use, personal use, and household use, but are not designed, developed and manufactured as contemplated (1) for use accompanying fatal risks or dangers that, unless extremely high safety is secured, could have a serious effect to the public, and could lead directly to death, personal injury, severe physical damage or other loss (i.e., nuclear reaction control in nuclear facility, aircraft flight control, air traffic control, mass transport control, medical life support system, missile launch control in weapon system), or (2) for use requiring extremely high reliability (i.e., submersible repeater and artificial satellite).

Please note that FUJITSU SEMICONDUCTOR will not be liable against you and/or any third party for any claims or damages arising in connection with above-mentioned uses of the products.

Any semiconductor devices have an inherent chance of failure. You must protect against injury, damage or loss from such failures by incorporating safety design measures into your facility and equipment such as redundancy, fire protection, and prevention of over-current levels and other abnormal operating conditions.

Exportation/release of any products described in this document may require necessary procedures in accordance with the regulations of the Foreign Exchange and Foreign Trade Control Law of Japan and/or US export control laws.

The company names and brand names herein are the trademarks or registered trademarks of their respective owners.